

# V 18 Laser – No frills performance: long ranges, high speeds with precision

	Photoelectric proximity switches
	Photoelectric reflex switches
	Through-beam photoelectric switches



**Laser class 1**  
(IEC 60825-1)

The photoelectric switch series V 18 L utilising the latest technology laser diodes, allies many years of sensor and applications know-how, with customer oriented features.

The strengths of our V 18 Laser:

- Laser class 1 (IEC 60825-1),
- extremely long ranges,
- smallest, visible light spots,
- very short response times.

The V 18 L and its ranges in overview:

- VSE 18 L through-beam photoelectric switches: 60 m;
- VL 18 L photoelectric reflex switches: 35 m (P 250 F), polarizing filter;

- VTE 18 L photoelectric proximity switches: energetic type, scr. 400 mm (90 % remission).

Additional standard features:

very short response time  $f = 800/s$  (1,000/s); manual sensitivity adjustment (VSE 18 L), or Teach-in (VL 18 L and VTE 18 L). The Teach-in provides easy handling and additional flexibility. Select:

- substantial operating reserve for standard applications,
- precise switching point and small hysteresis for special tasks.

High flexibility and functionality is available from a small number of variants as a result of: programmable switching type L.ON or D.ON by control line.  $V_S = 10 \dots 30 \text{ V DC}$ ; switching output Q either in PNP or NPN; M12 plug connector, IP 67 and sturdy metal housing (straight or 90 degree body styles) ...

Yellow and green LED indicators provide support during installation, operation startup, alignment and maintenance.

Whilst the V 18 L is suitable for any general purpose application, it will be of particular interest for applications in mechanical handling and logistics engineering, special mechanical engineering tasks, the packaging industry and conveyor engineering.

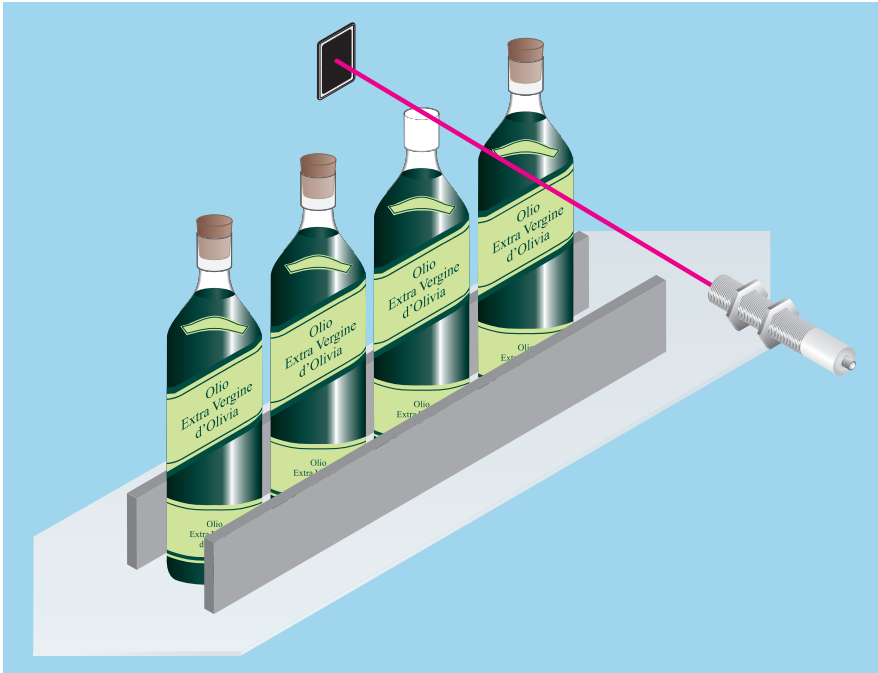

◀ The photoelectric reflex switch VL 18 L checks the presence of cork stoppers.

▶ The photoelectric proximity switch VTE 18 L detects marks and ensures precise positioning of circuit boards.

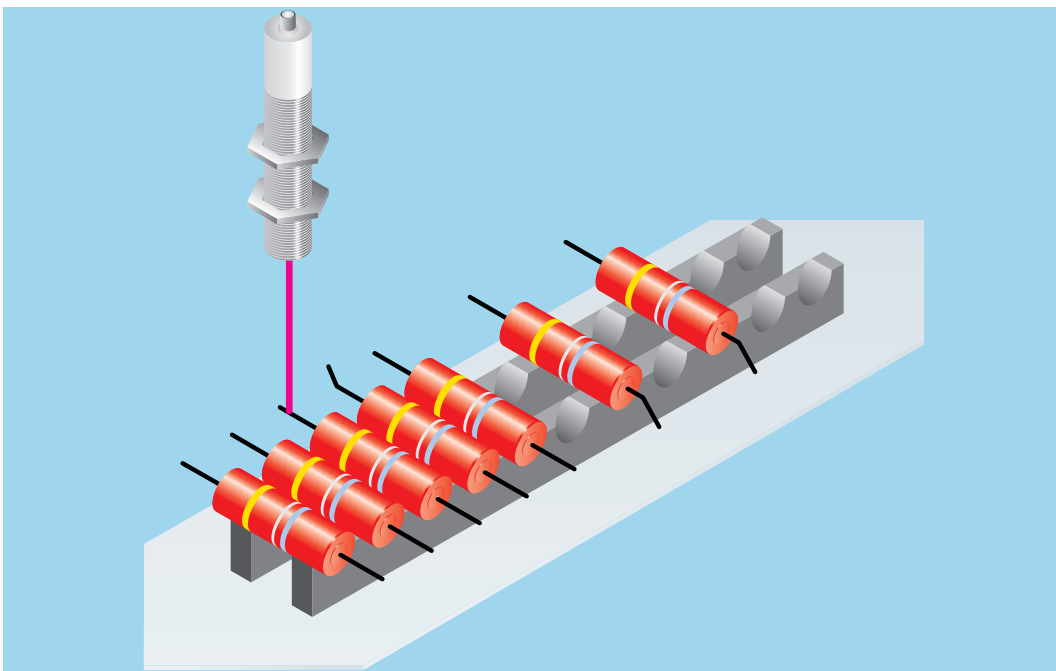
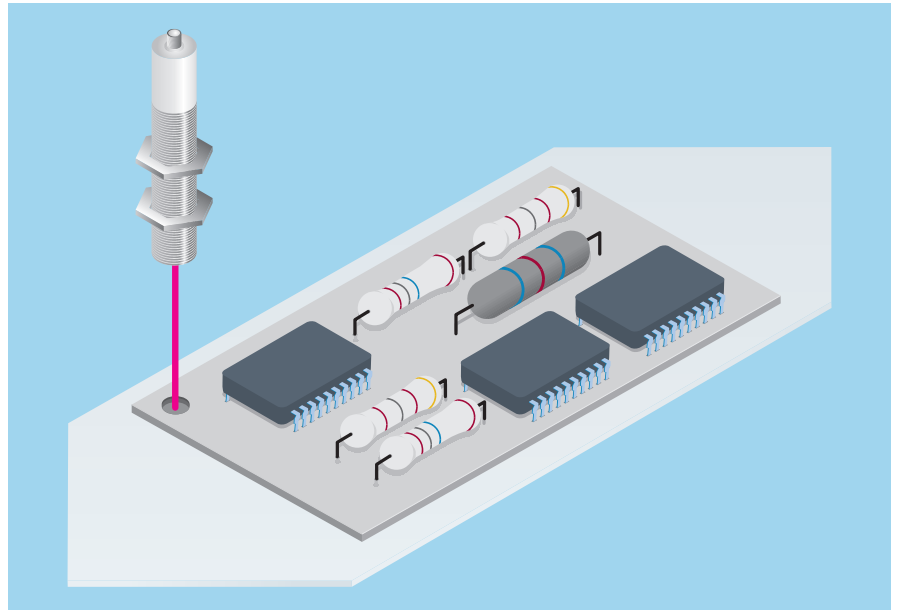

◀ The VTE 18 L detects thin wires on resistors prior to insertion.

	<b>Scanning distance</b>
	0 ... 400 mm
	2 ... 250 mm
<b>Photoelectric proximity switches</b>	

- Detects small parts and switches precisely thank to small laser spot
- Laser class 1
- Adjustable sensitivity

**Dimensional drawing**

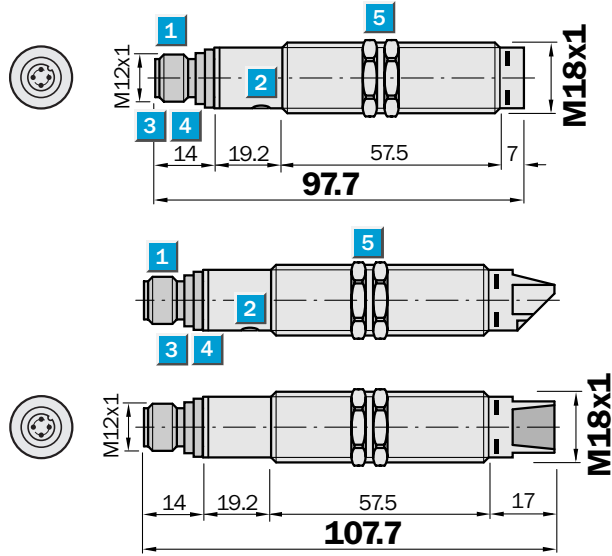

**Adjustments possible**

VTE 18 L-4P344	VTE 18 L-4P324
VTE 18 L-4N344	VTE 18 L-4N324

- 1** Plug M12, 4-pin
- 2** Sensitivity adjustment (Teach-in button)
- 3** Green LED indicator:  $V_S$  supply voltage feed
- 4** Yellow LED indicator:
  - lights continuously: reception signal > reserve factor 2
  - blinks: Reception signal < reserve factor 2 but > switching threshold 1
- 5** Mounting nuts (2x), SW 24, metal (included with delivery)

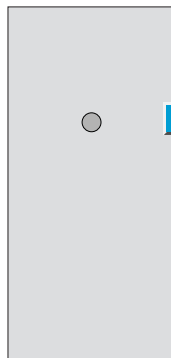

**Connection types**

VTE 18 L-4P344	VTE 18 L-4P324
VTE 18 L-4N344	VTE 18 L-4N324

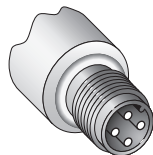

**4-pin, M12**

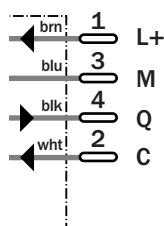

- \* Control input C, programming:
- Switching type L.ON/D.ON and External Teach-in
  - C = open (not assigned) light-switching L.ON
  - C = +  $V_S$ : dark-switching D.ON
  - C = 0 V: sensitivity setting per "external Teach-in" active



**Laser class 1**  
(IEC 60825-1)

<b>See chapter Accessories</b>
Cables and connectors
Mounting systems

Technical data		VTE 18 L-	4P324	4P344	4N324	4N344							
<b>Scanning distance</b> , max. typical <sup>1)</sup>	0 ... 400 mm												
	2 ... 250 mm												
<b>Operating distance</b> <sup>1)</sup>	5 ... 300 mm												
	5 ... 200 mm												
Minimum object diameter <sup>1)</sup>	= Light spot diameter												
Light spot diameter	Approx. 0.1 mm in 100 mm (= Focus)												
	Approx. 5.0 mm in 200 mm												
	Approx. 8.0 mm in 300 mm (only axial)												
Angle of dispersion of sender	Focused, focus at 100 mm												
<b>Light source</b> <sup>2)</sup> , <b>Light type</b>	Red laser LED, 650 nm												
Laser class	Laser class 1 (IEC 60825-1)												
Laser sender output capacity	Max. 0.4 mW												
<b>Housing</b>	Axial optics												
	Radial optics												
<b>Sensitivity setting</b>	Manual, per Teach-in button												
	Electronic, per control input C (0 V) <sup>3)</sup>												
<b>Status indicators</b>	Yellow LED: switching output active, reserve												
	LED green: supply voltage V <sub>S</sub> = ON												
<b>Supply voltage</b> V <sub>S</sub>	10 ... 30 V DC <sup>4)</sup>												
Ripple <sup>5)</sup>	≤ 10 %												
Current consumption <sup>6)</sup>	≤ 30 mA												
<b>Switching outputs</b>	Q: PNP												
	Q: NPN												
<b>Output current</b> I <sub>A</sub> max.	≤ 100 mA												
<b>Switching mode</b>	Light-/Dark-switching selectable <sup>3)</sup>												
Response time <sup>7)</sup>	≤ 0.625 ms												
Switching frequency max. <sup>8)</sup>	800/s												
<b>Connection types</b>	Plug M12, 4-pin												
<b>VDE protection class</b> <sup>9)</sup>	□												
<b>Enclosure rating</b>	IP 67												
<b>Circuit protection</b> <sup>10)</sup>	A, B, C, D												
<b>Ambient temperature</b>	Operation -15 °C ... +55 °C												
	Storage -25 °C ... +70 °C												
<b>Weight</b> with plug	Approx. 60 g												
<b>Housing material</b>	Housing: Nickel-coated brass/PC												
	Optics: PC with protective glass pane												

1) Object to be detected with 90 % emission (to standard white in acc. with DIN 5033); 100 x 100 mm  
 2) Average service life 100,000 h at T<sub>A</sub> = +25 °C

3) Control input C  
 - L.ON/D.ON and  
 - external Teach-in  
 C = open: light-switching L.ON  
 C = + V<sub>S</sub>: dark-switching D.ON  
 C = 0 V: Sensitivity setting per "external Teach-in"

4) Limit values  
 5) May not exceed or fall short of V<sub>S</sub> tolerances  
 6) Without load  
 7) Signal transit time with resistive load  
 8) With light/dark ratio 1:1  
 9) Reference voltage 50 V

10) A = V<sub>S</sub> connections reverse-polarity protected  
 B = Inputs and outputs reverse-polarity protected  
 C = Interference pulse suppression  
 D = Outputs overload and short-circuit protected

VTE 18 L operating diagrams

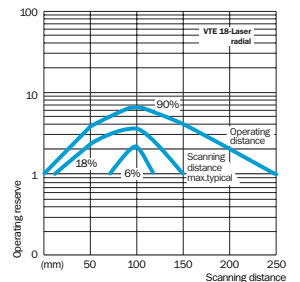
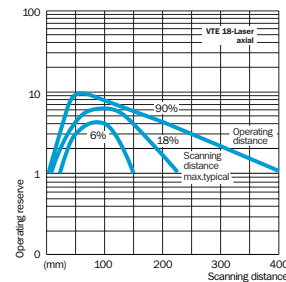
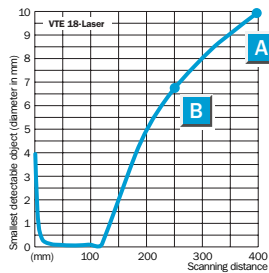
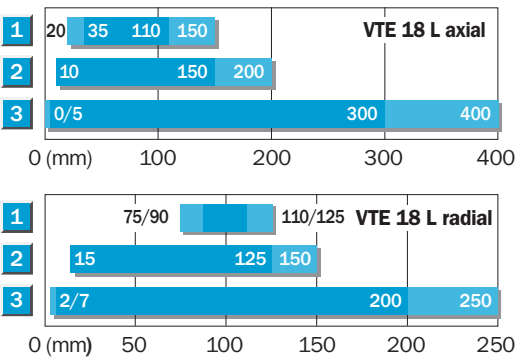

- 1 Scanning distance on black, 6 % remission
- 2 Scanning distance on grey, 18 % remission
- 3 Scanning distance on white, 90 % remission

- A Axial optics
- B Radial optics

Order information	
Type	Order no.
VTE 18 L-4P324	6 027 418
VTE 18 L-4N324	6 027 420
VTE 18 L-4P344	6 027 422
VTE 18 L-4N344	6 027 424

**Scanning range**  
 0.1 ... 35 m (P 250F)

Photoelectric reflex switches

- Longest ranges
- Detects small parts and switches precisely thank to small laser spot
- Laser class 1
- A polarisation filter ensures reliable switching even with shiny objects

**Dimensional drawing**

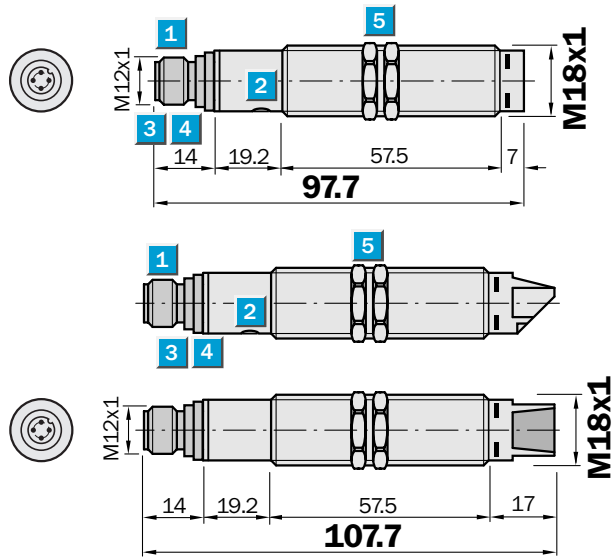

**Adjustments possible**

VL 18 L-4P344	VL 18 L-4P324
VL 18 L-4N344	VL 18 L-4N324

- 1** Plug M12, 4-pin
- 2** Sensitivity adjustment (Teach-in button)
- 3** Green LED indicator:  $V_S$  supply voltage feed
- 4** Yellow LED indicator:
  - lights continuously: reception signal > reserve factor 2
  - blinks: Reception signal < reserve factor 2 but > switching threshold 1
- 5** Mounting nuts (2x), SW 24, metal (included with delivery)

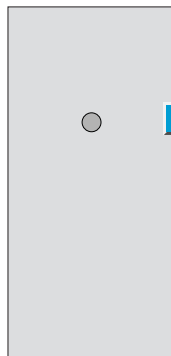

**Connection types**

VL 18 L-4P344	VL 18 L-4P324
VL 18 L-4N344	VL 18 L-4N324

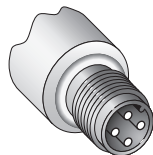

**4-pin, M12**

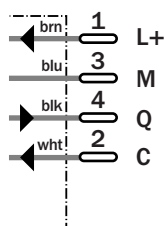

- \* Control input C, programming:
- Switching type L.ON/D.ON and
  - External Teach-in
  - C = open (not assigned) dark-switching D.ON
  - C = +  $V_S$ : light-switching L.ON
  - C = 0 V: sensitivity setting per “external Teach-in” active



**Laser class 1**  
(IEC 60825-1)

**See chapter Accessories**

- Cables and connectors
- Mounting systems
- Reflectors

Technical data		VL 18 L-	4P324	4P344	4N324	4N344							
<b>Scanning range</b> , max. typical/Reflector	0.1 m ... 35 m/P 250 F												
Operating range <sup>1)</sup>	0.1 m ... 30 m/P 250 F												
Smallest detectable object <sup>1)</sup>	Approx. 0.7 mm Ø at 1 m												
	Approx. 25 mm Ø at 35 m												
Light spot diameter	Approx. 9 mm at 35 m												
Angle of dispersion of sender	Approx. 0.04° (SR = max.)												
	Approx. 0.02° (SR = 1/2 max.)												
<b>Light source <sup>2)</sup>, Light type</b>	Red laser light, 650 nm												
Laser class	Laser class 1 (IEC 60825-1)												
Laser sender output capacity	Max. 0.4 mW												
<b>Housing</b>	Axial optics												
	Radial optics												
<b>Sensitivity setting</b>	Manual, per Teach-in button												
	Electronic, per control input C (0 V) <sup>3)</sup>												
<b>Status indicators</b>	Yellow LED:												
	Switching output active, reserve												
	LED green: supply voltage V <sub>S</sub> = ON												
<b>Supply voltage V<sub>S</sub></b>	10 ... 30 V DC <sup>4)</sup>												
Ripple <sup>5)</sup>	≤ 10 %												
Current consumption <sup>6)</sup>	≤ 20 mA												
<b>Switching outputs</b>	Q: PNP												
	Q: NPN												
<b>Output current I<sub>A</sub> max.</b>	≤ 100 mA												
<b>Switching mode</b>	Light-/Dark-switching selectable <sup>3)</sup>												
Response time <sup>7)</sup>	≤ 0.625 ms												
Switching frequency max. <sup>8)</sup>	800/s												
<b>Connection types</b>	Plug M12, 4-pin												
<b>VDE protection class <sup>9)</sup></b>	□												
<b>Enclosure rating</b>	IP 67												
<b>Circuit protection <sup>10)</sup></b>	A, B, C, D												
<b>Ambient temperature</b>	Operation -15 °C ... +55 °C												
	Storage -25 °C ... +70 °C												
<b>Weight</b>	with plug												
	Approx. 60 g												
<b>Housing material</b>	Housing: Nickel-coated brass/PC												
	Optics: PC with protective glass pane												

- <sup>1)</sup> Suitable reflectors for laser photoelectric reflex switches: We recommend our "F" reflectors with micro triple structure or DG reflector tape for short distances up to 5 m and our standard reflectors for ranges > 5 m (also see the accessories; reflectors for VL 18 L)
- <sup>2)</sup> Average service life 100,000 h at T<sub>A</sub> = +25 °C
- <sup>3)</sup> Control input C  
 - L.ON/D.ON and - external Teach-in  
 C = open: dark-switching D.ON  
 C = + V<sub>S</sub>: light-switching L.ON
- C = 0 V: Sensitivity setting per "external Teach-in"
- <sup>4)</sup> Limit values  
<sup>5)</sup> May not exceed or fall short of V<sub>S</sub> tolerances  
<sup>6)</sup> Without load  
<sup>7)</sup> Signal transit time with resistive load  
<sup>8)</sup> With light/dark ratio 1:1
- <sup>9)</sup> Reference voltage 50 V  
<sup>10)</sup> A = V<sub>S</sub> connections reverse-polarity protected  
 B = Inputs and outputs reverse-polarity protected  
 C = Interference pulse suppression  
 D = Outputs overload and short-circuit protected

**Operating range and operating reserve**

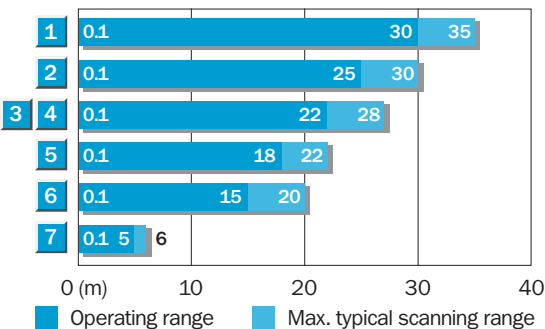

Reflector type	Operating range
1 P 250 F	0.1 - 30 m
2 PL 10 F	0.1 - 25 m
3 4 PL 80 A/P 250	0.1 - 22 m
5 C 110	0.1 - 18 m
6 PL 20 F	0.1 - 15 m
Reflective tape "Diamond Grade"	0.1 - 5 m

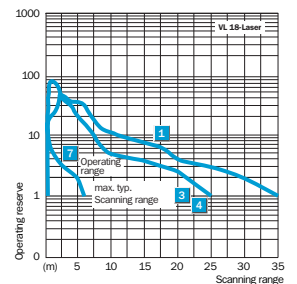
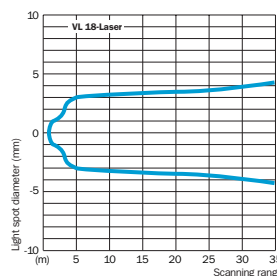
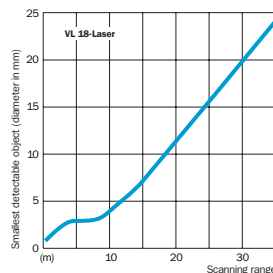

Order information	
Type	Order no.
VL 18 L-4P324	6 027 430
VL 18 L-4N324	6 027 432
VL 18 L-4P344	6 027 434
VL 18 L-4N344	6 027 436

**Scanning range**  
0 ... 60 m

Through-beam photoelectric switches

- Longest ranges
- Detects small parts and switches precisely thanks to small laser spot
- Laser class 1
- Optionally (integrated) horizontal and radial optic axes

**Dimensional drawing**

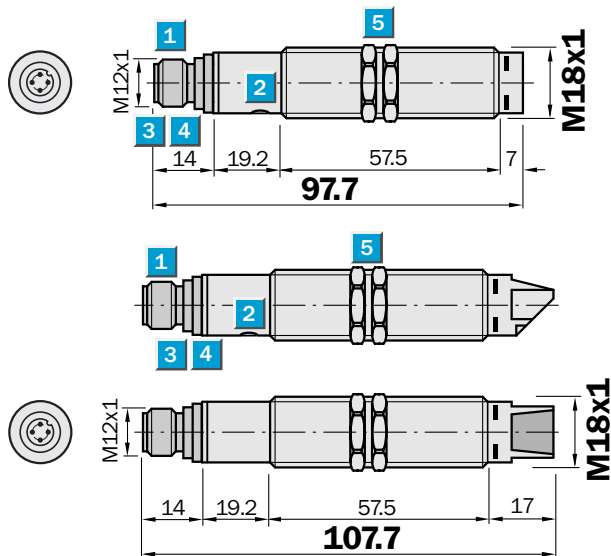

**Adjustments possible**

VE 18 L-4P324	VE 18 L-4P344
VE 18 L-4N324	VE 18 L-4N344

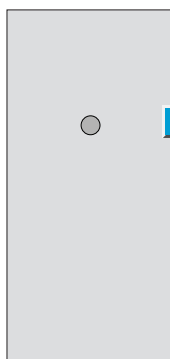

- 1 Plug M12, 4-pin
- 2 Sensitivity adjustment, trimmer 270° (only receiver VE 18 L)
- 3 Green LED indicator:  $V_S$  supply voltage feed
- 4 Yellow LED indicator (only receiver VE 18 L),
  - lights continuously: reception signal > reserve factor 2
  - blinks: Reception signal < reserve factor 2 but > switching threshold 1
- Yellow LED indicator (only sender VS 18 L),
  - lights continuously: Sender active
  - does not light: Sender off
- 5 Mounting nuts (2x), SW 24, metal (included with delivery)

**Connection types**

VS 18 L-0D314	VE 18 L-4P324
VS 18 L-0D334	VE 18 L-4N324
	VE 18 L-4P344
	VE 18 L-4N344

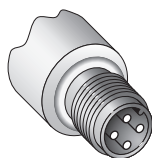

Laser class 1  
(IEC 60825-1)

**See chapter Accessories**

- Cables and connectors
- Mounting systems

Sender VS	Receiver VE
3-pin, M12	4-pin, M12

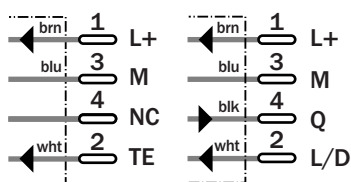

Technical data		VS 18 L-/VE 18 L-	0D314	0D334		4P324	4P344	4N324	4N344			
<b>Scanning range SR</b> , max. typical	0 ... 60 m											
<b>Operating range SR</b>	0 ... 50 m											
Smallest detectable object	Approx. 0.5 mm Ø at 1 m											
	Approx. 0.8 mm Ø at 2 m											
	Approx. 10 mm Ø at 50 m											
Light spot diameter	Approx. 40 mm at 50 m											
Angle of dispersion of sender	Approx. 0.06° (SR = max.)											
	Approx. 0.04° (SR = 1/2max.)											
Receiver reception angle	Approx. 0.08° (SR = max.)											
	Approx. 0.06° (SR = 1/2max.)											
Light source <sup>1)</sup> Light type	Red laser light, 650 nm											
Laser class	Laser class 1 (IEC 60825-1)											
Laser sender output capacity	Max. 0.4 mW											
<b>Housing</b>	Axial optics											
	Radial optics											
<b>Sensitivity setting</b>	Trimmer 270° (only receiver VE 18 L)											
<b>Status indicators</b>	Yellow LED:											
	Switching output/sender active											
	LED green: supply voltage $V_S$ = ON											
<b>Supply voltage <math>V_S</math></b>	10 ... 30 V DC <sup>2)</sup>											
Ripple <sup>3)</sup>	≤ 10 %											
Current consumption <sup>4)</sup>	≤ 25 mA											
<b>Switching outputs</b>	Q: PNP											
	Q: NPN											
<b>Output current <math>I_A</math> max.</b>	≤ 100 mA											
<b>Switching mode</b>	Light-/Dark-switching selectable <sup>5)</sup>											
Response time <sup>6)</sup>	≤ 0.5 ms											
Switching frequency max. <sup>7)</sup>	1000/s											
<b>Test input »TE«</b>	0 V = Sender not active											
<b>Connection types</b>	Plug M12											
<b>VDE protection class <sup>8)</sup></b>	□											
<b>Enclosure rating</b>	IP 67											
<b>Circuit protection <sup>9)</sup></b>	A, B, C, D											
<b>Ambient temperature</b>	Operation -15 °C ... +55 °C											
	Storage -25 °C ... +70 °C											
<b>Weight</b> with plug	Approx. 60 g											
<b>Housing material</b>	Housing: Nickel-coated brass/PC											
	Optics: PC with protective glass pane											

- 1) Average service life 100,000 h at  $T_A = +25$  °C
- 2) Limit values
- 3) May not exceed or fall short of  $V_S$  tolerances
- 4) Without load

- 5) L/D switching type control line  
L/D = open (not assigned)  
dark-switching D.ON  
L/D = +  $V_S$ : light-switching L.ON  
L/D = 0 V: dark-switching D.ON
- 6) Signal transit time with resistive load

- 7) With light/dark ratio 1:1
- 8) Reference voltage 50 V
- 9) A =  $V_S$  connections reverse-polarity protected  
B = Inputs and output reverse-polarity protected

C = Interference pulse suppression  
D = Outputs overload and short-circuit protected

**Operating range and operating reserve**

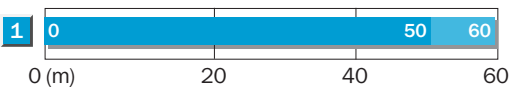

■ Operating range    ■ Max. typical scanning range

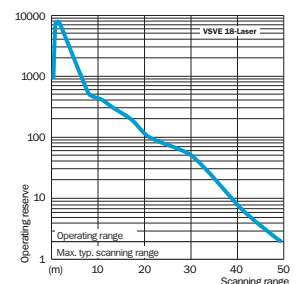
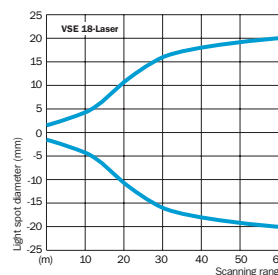

**Order information (packaging unit VSE 18 L = VS 18 L + VE 18 L)**

Type	Order no.	Type	Order no.
VSE 18 L-4P324	6 027 931	VSE 18 L-4P344	6 027 935
VSE 18 L-4N324	6 027 933	VSE 18 L-4N344	6 027 937