



W 260 series standard photoelectric switches for a wide range of applications

	Photoelectric proximity switches, BGS
	Photoelectric proximity switches, energetic
	Photoelectric reflex switches





The easily accessible terminal chamber electrical connection ensures that the sensor can be connected and commissioned easily and quickly. Furthermore, mounting brackets and reflector (WL 260 only) are included in the supply.

Overview of W 260:

- 6 different detection systems in one configuration = standardised mounting system,
- DC/AC devices conform to EN 61000-6-3 (interference emission in “residential and commercial areas”),
- comprehensive range of fibre-optic cables covers many applications,
- universal supply voltage.

Main industries:

- Plastics technology,
- Materials handling,
- Mechanical engineering,
- Door/gate and, access control.

	Through-beam photoelectric switches
	Photoelectric fibre-optic switches (proximity)
	Photoelectric fibre-optic switches (through-beam)

The W 260 series with its sensible ranges and useful technical features is superbly designed for a wide range of applications. Six different detection methods are available in one configuration, saving on mounting systems and stockholding.

The outstanding features are the long ranges and scanning distances of each system.

The sensor, with a variety of adjustable features including teach-in for a fast set-up, is ideally suited to a wide range of applications. Glass and stainless steel fibre-optic cables open up new areas of application in restricted environments.

► The WT 260 photoelectric proximity switch is used for height control in a packaging machine.

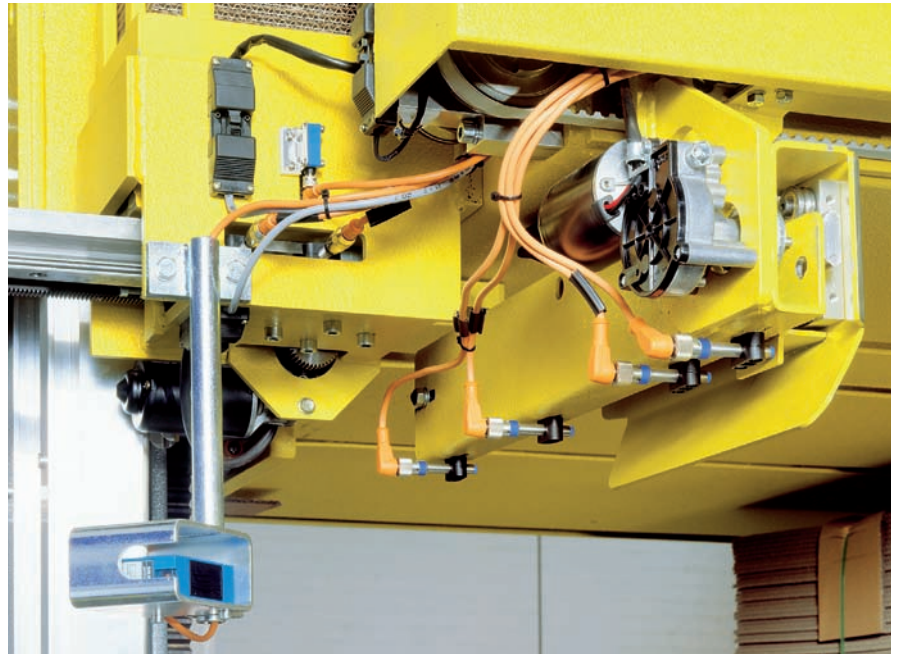

▼ CE conformity to EN 61000-6-3 and, therefore, the right choice for residential and commercial applications: the WL 260 photoelectric reflex switch used to monitor the closing edges in automatic door and gate systems.



▲ A WT 260 photoelectric proximity switch controlling a commissioning system used in the wood-working industry.

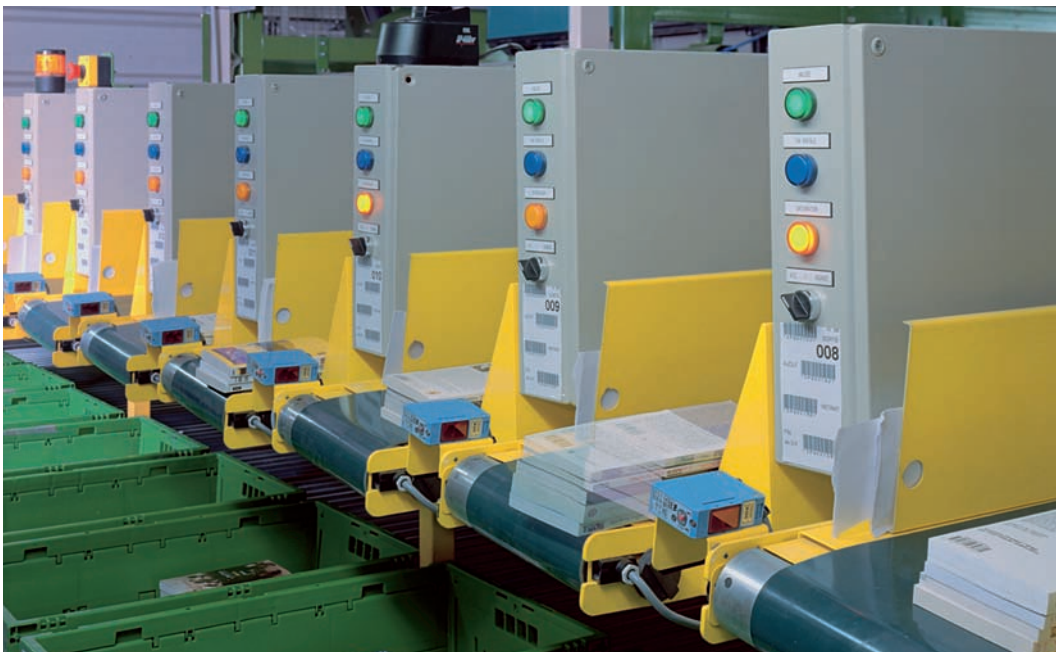

◀ WL 260 photoelectric reflex switches with a small light spot are used to ensure reliable mail order operations.

Scanning distance
 0.07 ... 2.1 m
Photoelectric proximity switch

- Teach-in, ready to operate in less time
- Background suppression:
Reliable detection of dark objects even against light backgrounds
- Terminal chamber or M12 plug, 4-pin
- LED signal indicator green
Operating reserve/Pre-failure display

Dimensional drawing

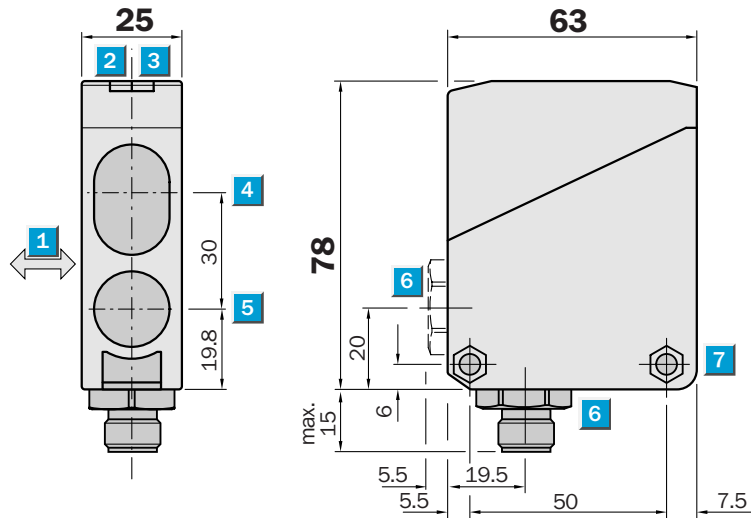

Adjustments possible

WT 260T-P 290
WT 260T-P 490
WT 260T-N 290
WT 260T-N 490

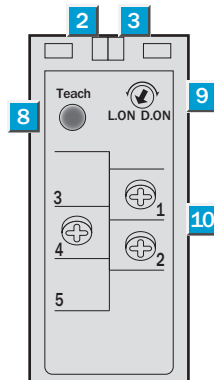

- 1 Standard direction of material being scanned
- 2 LED signal indicator orange, switching output active
- 3 LED signal indicator green, operating reserve
- 4 Middle of optic axis, receiver
- 5 Middle of optic axis, sender
- 6 Cable entry gland 1/2" PF thread for cable diameters from 6 to 10 mm optionally at bottom or rear; or M12 equipment plug bottom (4-pin)
- 7 Through hole Ø 5.2 mm on both sides for M5 hex nut
- 8 Teach-in button (scanning distance setting/background suppression)
- 9 Light/dark-switching (L.ON = light-switching, D.ON = dark-switching)
- 10 Terminals

Connection types

WT 260T-P 290	WT 260T-P 490
WT 260T-N 290	WT 260T-N 490

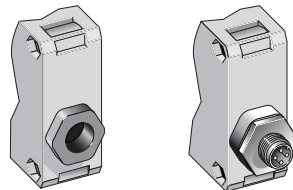

Terminals

4-pin, M12

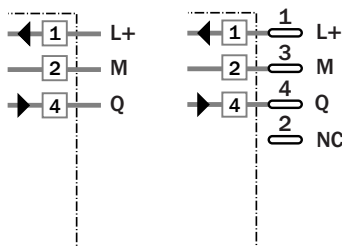

See chapter Accessories

- Cables and connectors
- Mounting systems^{*)}

^{*)} Mounting bracket included with delivery

Technical data		WT 260T-	P 290	P 490	N 290	N 490						
Scanning distance, typ. max.	70 mm ... 2100 mm ¹⁾											
Recommended operating scanning dist.	100 mm ... 2000 mm ¹⁾											
Scanning distance setting	Automatic, per Teach-in button											
Light source ²⁾	LED, infrared											
Light spot diameter	Approx. 200 mm at 2000 mm											
Aperture angle sender	Approx. 6°											
Supply voltage V_s	10 ... 30 VDC ³⁾											
Ripple ⁴⁾	≤ 10 %											
Current consumption ⁵⁾	≤ 55 mA											
Switching outputs	PNP, open collector: Q NPN, open collector: Q											
Output current I _A max.	100 mA											
Light receiver, switching mode	Light-/dark-switching by rotary switch											
Response time ⁶⁾	≤ 5 ms											
Switching frequency max. ⁷⁾	100/s											
Connection types	Terminal chamber Plug M12, 4-pin											
VDE protection class ⁸⁾	<input type="checkbox"/>											
Circuit protection ⁹⁾	A, B, C, D											
Enclosure rating	IP 67											
Ambient temperature T_A	Operation -25 °C ... +55 °C Storage -40 °C ... +70 °C											
Weight	Approx. 120 g											
Material	Housing: ABS; Optics: PMMA											

- ¹⁾ Object with 90 % remission (based on standard white DIN 5033)
 - ²⁾ Average service life 100,000 h at T_A = +25 °C
 - ³⁾ Limit values, operation in short circuit protected network max. 8 A
 - ⁴⁾ Must be within V_s tolerances
 - ⁵⁾ Without load
 - ⁶⁾ With resistive load
 - ⁷⁾ With light/dark ratio 1:1
 - ⁸⁾ Reference voltage 50 V DC
 - ⁹⁾ A = V_s connections reverse-polarity protected
- B = Outputs Q and \bar{Q} reverse-polarity protected
C = Interference suppression
D = Outputs overcurrent and short-circuit protected

Scanning distance

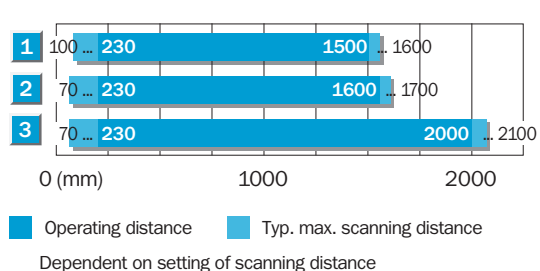

- 1 Scanning range on black, 6 % remission
- 2 Scanning range on gray, 18 % remission
- 3 Scanning range on white, 90 % remission

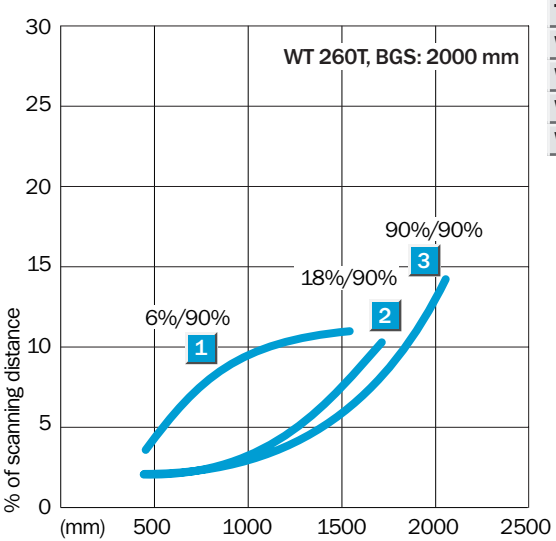

Order information

Type	Order no.
WT 260T-P 290	6 021 919
WT 260T-P 490	6 021 920
WT 260T-N 290	6 021 921
WT 260T-N 490	6 021 922

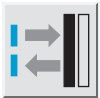
Scanning distance
 0.07 ... 2.1 m
 Photoelectric proximity switch

- Universal voltage
- Teach-in, ready to operate in less time
- Background suppression:
Reliable detection of dark objects even against light backgrounds
- Terminal chamber
- Relay output, SPDT, time delays

Dimensional drawing

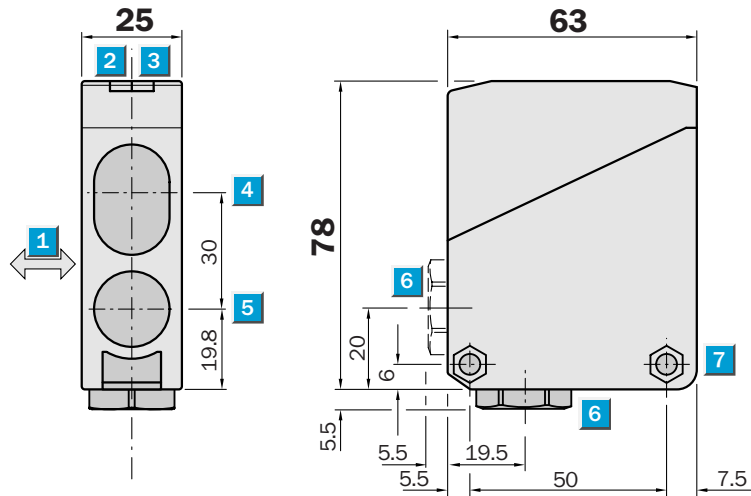

Adjustments possible

WT 260T-S 290	WT 260T-R 290
---------------	---------------

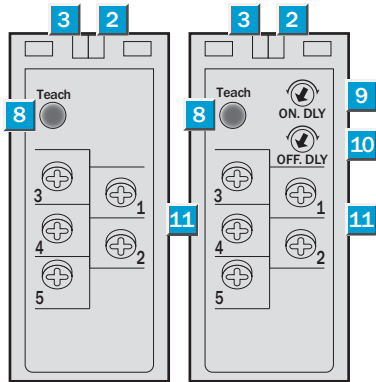

- 1 Standard direction of material being scanned
- 2 LED signal indicator orange, switching output active
- 3 LED signal indicator green, operating reserve
- 4 Middle of optic axis, receiver
- 5 Middle of optic axis, sender
- 6 Cable entry gland 1/2" PF thread for cable diameters from 6 to 10 mm optionally at bottom or rear;
- 7 Through hole Ø 5.2 mm on both sides for M5 hex nut
- 8 Teach-in button (scanning distance setting/ background suppression)
- 9 Time control ON delay t_{ON}
- 10 Time control OFF delay t_{OFF}
- 11 Terminals

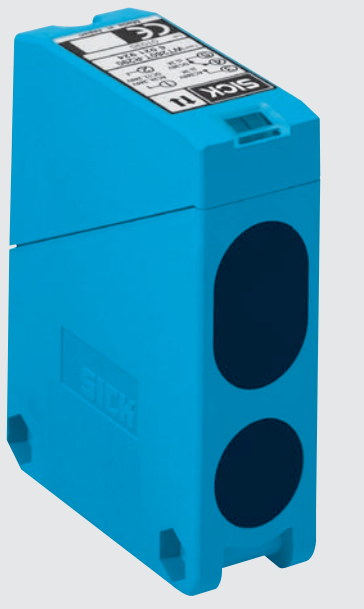

Connection types

WT 260T-S 290
WT 260T-R 290

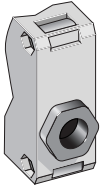

Terminals

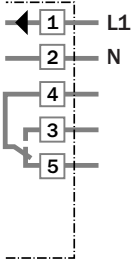

See chapter Accessories
Mounting systems^{*)}

^{*)} Mounting bracket included with delivery

Technical data		WT 260T-	S 290	R 290								
Scanning distance, typ. max.	70 mm ... 2100 mm ¹⁾											
Recommended operating scanning dist.	100 mm ... 2000 mm ¹⁾											
Scanning distance setting	Automatic, per Teach-in button											
Light source²⁾	LED, infrared											
Light spot diameter	Approx. 200 mm at 2000 mm											
Aperture angle sender	Approx. 6°											
Supply voltage V_s³⁾	12 to 240 V DC											
	24 to 240 V UC											
Power consumption	≤ 5 VA											
Switching outputs	Relay, SPDT, electrically isolated ⁴⁾											
Switching current I max.	3 A/240 V AC; 3 A/30 V DC ⁵⁾											
Light receiver, switching mode	Light-switching											
Response time	≤ 20 ms											
Switching frequency max. ⁶⁾	25/s											
Time delay												
ON delay t _{ON}	0.1 ... 10 s, can be connected separately											
OFF delay t _{OFF}	0.1 ... 10 s, can be connected separately											
Connection type	Terminal chamber											
VDE protection class⁷⁾	<input type="checkbox"/>											
Circuit protection⁸⁾	A, C											
Enclosure rating	IP 67											
Ambient temperature T_A	Operation - 25 °C to + 55 °C											
	Storage - 40 °C to + 70 °C											
Weight	Approx. 120 g											
Material	Housing: ABS; Optics: PMMA											

¹⁾ Object with 90 % remission (based on standard white DIN 5033)

²⁾ Average service life 100,000 h at T_A = + 25 °C

³⁾ ± 10 %

⁴⁾ Provide suitable spark suppression for inductive or capacitive loads

⁵⁾ Usage categorie to EN 60947-1, 15 AC, 13 DC

⁶⁾ With light/dark ratio 1:1

⁷⁾ Reference voltage 250 V UC

⁸⁾ A = V_s connections reverse-polarity protected

C = Interference suppression

Scanning distance

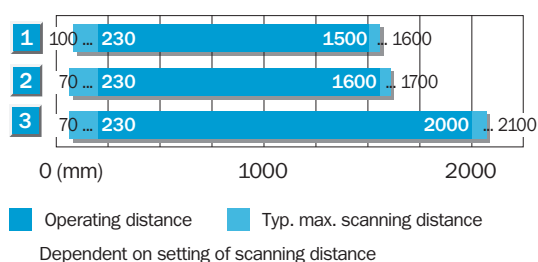

- 1 Scanning range on black, 6 % remission
- 2 Scanning range on gray, 18 % remission
- 3 Scanning range on white, 90 % remission

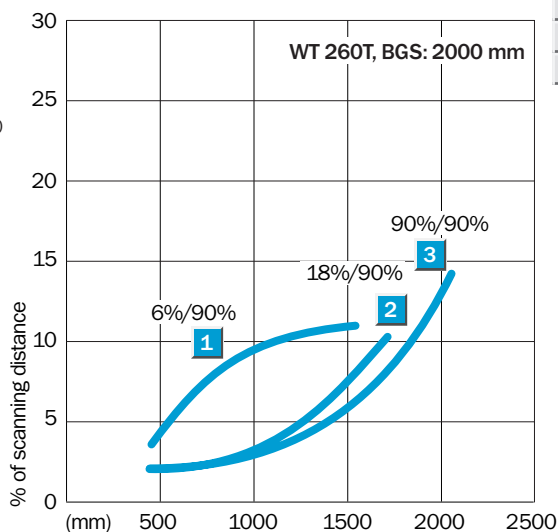

Order information

Type	Order no.
WT 260T-S 290	6 021 923
WT 260T-R 290	6 021 924

Scanning distance
 0 ... 380 mm
Photoelectric proximity switch

- Reliable detection of dark objects even against light backgrounds
- Scanning distance steplessly adjustable
- Terminal chamber or M12 plug, 4-pin or 5-pin
- Test input
- Contamination signaling output

Dimensional drawing

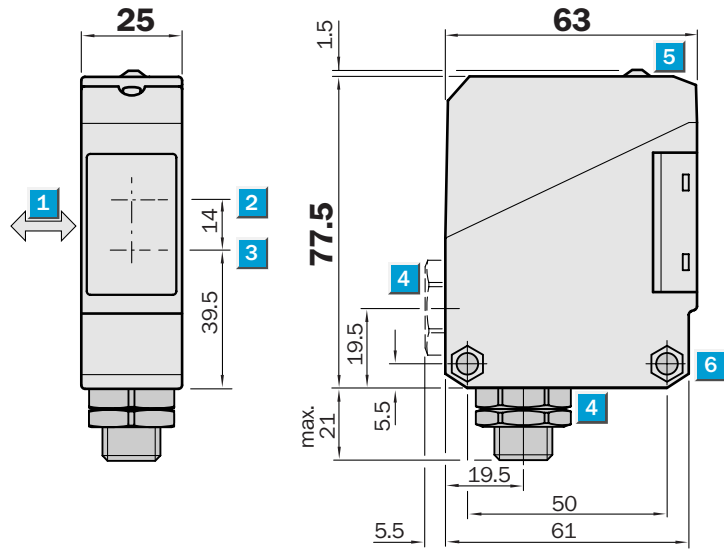

Adjustments possible

- WT 260-P 260
- WT 260-P 460
- WT 260-P 560

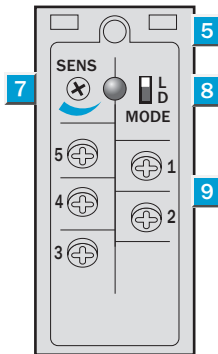

- 1 Standard direction of material being scanned
- 2 Middle optic axis, receiver
- 3 Middle optic axis, sender
- 4 Cable entry gland 1/2" PF thread for cable diameters from 6 to 10 mm optionally at bottom or rear; or M12 equipment plug, bottom
- 5 LED signal strength indicator, red
- 6 Through hole \varnothing 5.2 mm on both sides for M5 hex nut
- 7 Scanning distance control
- 8 Light/dark rotary switch
L.ON = light-switching, D.ON = dark-switching
- 9 Terminals



Connection types

- WT 260-P 260
- WT 260-P 460
- WT 260-P 560

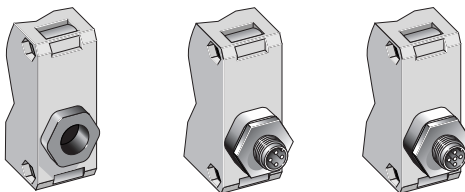

Terminals

4-pin, M12

5-pin, M12

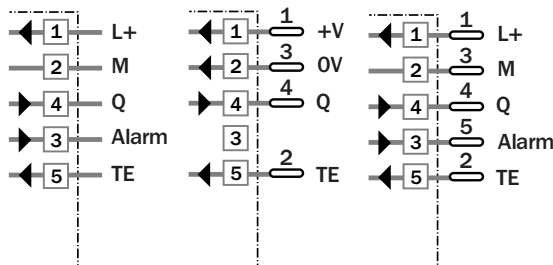

See chapter Accessories

Cables and connectors

Mounting systems^{*)}

^{*)} Mounting bracket included with delivery

Technical data		WT 260-	P 260	P 460 ¹⁾	P 560 ¹⁾
Scanning distance	Max.: 0 ... 380 mm, adjustable ²⁾				
	Min.: 75 ... 160 mm, adjustable ²⁾				
Scanning distance setting	per potentiometer 270°				
Light source³⁾	LED, infrared				
Light spot diameter	Approx. 17 mm at 300 mm				
Aperture angle sender	Approx. 1,5°				
Supply voltage V_s	10 to 30 VDC ⁴⁾				
Ripple ⁵⁾	≤ 5 V _{PP}				
Current consumption ⁶⁾	≤ 35 mA				
Switching outputs	PNP, open collector: Q				
Output current I _A max.	100 mA				
Light receiver, switching mode	Light-/dark-switching by rotary switch				
Response time ⁷⁾	≤ 2 ms				
Switching frequency max. ⁸⁾	250/s				
Contamination signaling output VMA ⁹⁾	Alarm 100 mA, static				
Test input »TE« sender off	PNP: TE to + V _s				
Connection types	Terminal chamber				
	Plug M12, 4-pin				
	Plug M12, 5-pin				
VDE protection class¹⁰⁾	□				
Circuit protection¹¹⁾	A, B, C, D				
Enclosure rating	IP 66				
Ambient temperature T_A	Operation -25 °C ... +55 °C				
	Storage -40 °C ... +70 °C				
Weight	Approx. 120 g				
Material	Housing: ABS; Optic: PC				

- 1) Without
- 2) Object with 90 % remission (based on standard white DIN 5033)
- 3) Average service life 100,000 h at T_A = +25 °C

- 4) Limit values, operation in short circuit protected network max. 8 A
- 5) Must be within V_s tolerances
- 6) Without load
- 7) With resistive load

- 8) With light/dark ratio 1:1
- 9) Operating reserve <50 %
- 10) Reference voltage 50 V DC
- 11) A = V_s connections reverse-polarity protected

- B = Inputs/outputs reverse-polarity protected
- C = Interference suppression
- D = Outputs overcurrent and short-circuit protected

Scanning distance

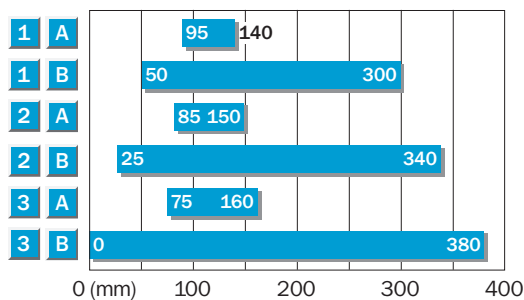

- 1 Scanning range on black, 6 % remission
- 2 Scanning range on grey, 18 % remission
- 3 Scanning range on white, 90 % remission
- A Scanning distance control set to MIN
- B Scanning distance control set to MAX

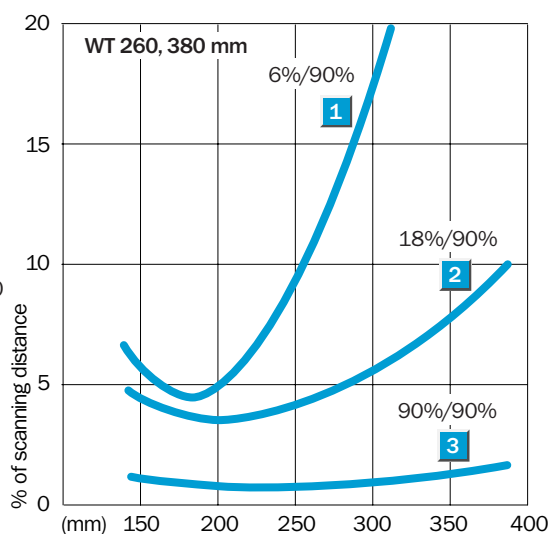

Order information

Type	Order no.
WT 260-P 260	6 009 471
WT 260-P 460	1 011 540
WT 260-P 560	1 011 541

Scanning distance
 0 ... 380 mm
 Photoelectric proximity switch

- Universal voltage
- Reliable detection of dark objects even against light backgrounds
- Scanning distance steplessly adjustable
- Terminal chamber
- Relay output, SPDT, time delays

Dimensional drawing

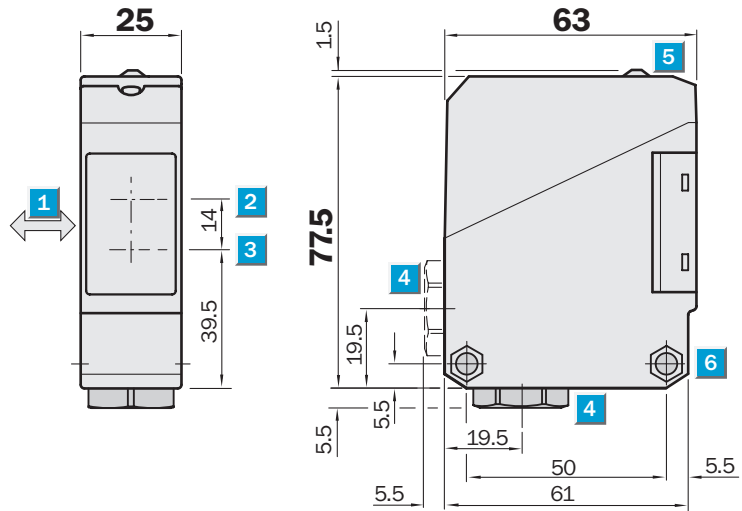

Adjustments possible

WT 260-S 260 WT 260-R 260

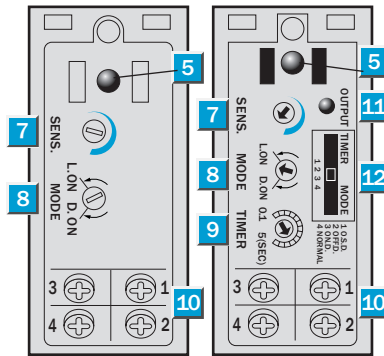

- 1 Standard direction of material being scanned
- 2 Middle of optic axis, receiver
- 3 Middle of optic axis, sender
- 4 Cable entry gland 1/2" PF thread for cable diameters from 6 to 10 mm optionally at bottom or rear;
- 5 LED signal strength indicator, red
- 6 Through hole Ø 5.2 mm on both sides for M5 hex nut
- 7 Scanning distance control
- 8 Light/dark rotary switch
L.ON = light-switching, D.ON = dark-switching
- 9 Time control
- 10 Terminals
- 11 Red LED status indicator; switching output active
- 12 Time delay selector switch
O.S.D. = One Shot
OFF.D. = OFF delay
ON.D. = ON delay
Normal = No delay



Connection types

WT 260-S 260
WT 260-R 260

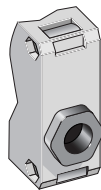

Terminals

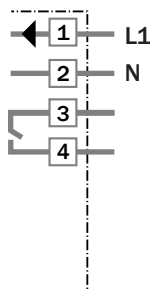

Time delays

t = 0.1–5 s

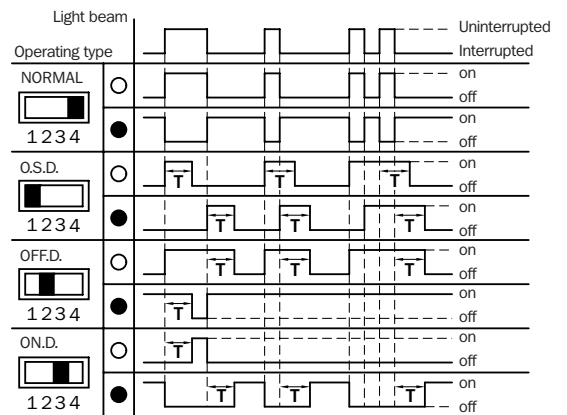

See chapter Accessories

Mounting systems^{*)}

^{*)} Mounting bracket included with delivery

Technical data		WT 260-	S 260	R 260								
Scanning distance	max.: 0 ... 380 mm, adjustable ¹⁾											
	min.: 75 ... 160 mm, adjustable ¹⁾											
	Scanning distance setting	per potentiometer 270°										
Light source²⁾	LED, infrared											
	Light spot diameter	Approx. 17 mm at 300 mm										
	Aperture angle sender	Approx. 1,5°										
Supply voltage V_s³⁾	12 to 240 V DC											
	24 to 240 V UC											
Current consumption	≤ 5 VA											
Switching outputs	Relay, SPDT, electrically isolated ⁴⁾											
	Output current I _A max.	3 A/240 V AC; 3 A/30 V DC ⁵⁾										
	Light receiver, switching mode	Light-/dark-switching by rotary switch										
	Response time	≤ 20 ms										
	Switching frequency max. ⁶⁾	25/s										
Time delay	With LED display: switching output active											
	Switch position: "1 O.S.D."	"One shot"										
	"2 OFF.D."	OFF delay										
	"3 ON.D."	ON delay										
	"4 Normal"	No delay										
Delay	Adjustable, 0.1 to 5 s; potentiometer 270°											
Connection type	Terminal chamber											
VDE protection class⁷⁾	<input type="checkbox"/>											
Circuit protection⁸⁾	A, C											
Enclosure rating	IP 66											
Ambient temperature T_A	Operation	-25 °C ... +55 °C										
	Storage	-40 °C ... +70 °C										
Weight	Approx. 120 g											
Material	Housing: ABS; Optic: PC											

¹⁾ Object with 90 % remission (based on standard white DIN 5033)
²⁾ Average service life 100,000 h at T_A = +25 °C

³⁾ ± 10 %
⁴⁾ Provide suitable spark suppression for inductive or capacitive loads

⁵⁾ Usage categorie to EN 60947-1, 15 AC, 13 DC
⁶⁾ With light/dark ratio 1:1

⁷⁾ Reference voltage 250 V UC
⁸⁾ A = V_s connections reverse-polarity protected
 C = Interference suppression

Scanning distance

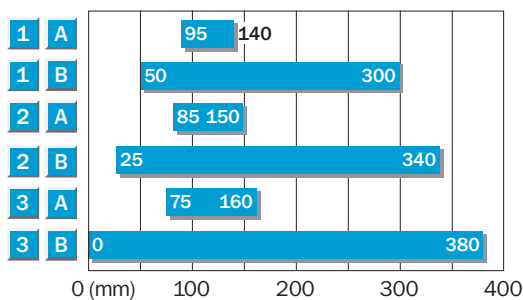

- 1 Scanning range on black, 6 % remission
- 2 Scanning range on grey, 18 % remission
- 3 Scanning range on white, 90 % remission
- A Scanning distance control set to MIN
- B Scanning distance control set to MAX

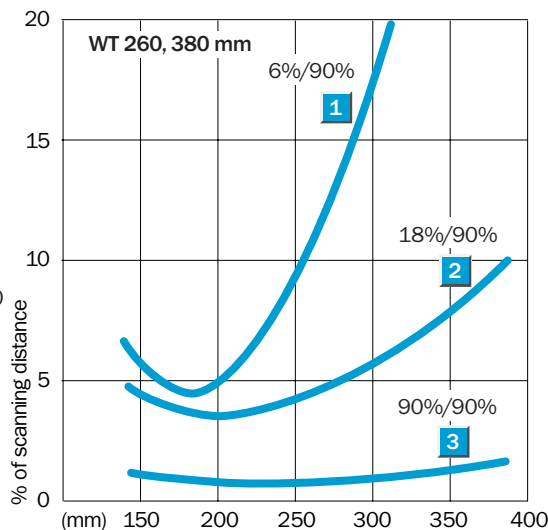

Order information

Type	Order no.
WT 260-S 260	6 009 473
WT 260-R 260	6 009 472

Scanning distance
10 ... 3200 mm
 Photoelectric proximity switch

- Infrared light, very high scanning distance
- Terminal chamber or plug
- M12, 4-pin Test input

Dimensional drawing

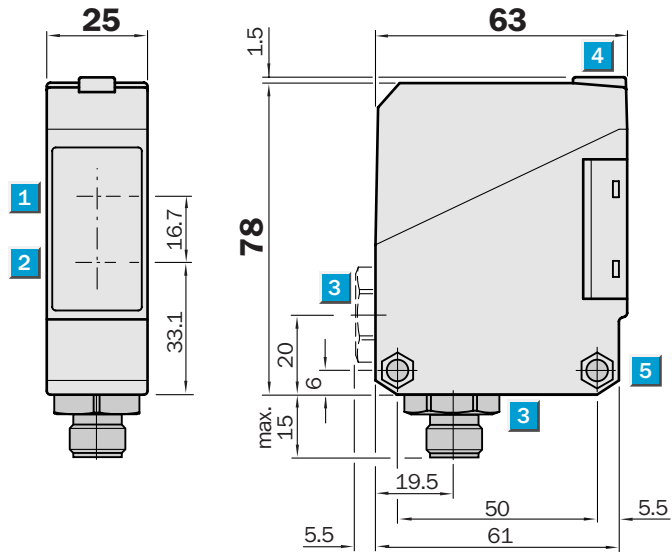

Adjustments possible

WT 260-F 280
WT 260-F 480
WT 260-E 280
WT 260-E 480

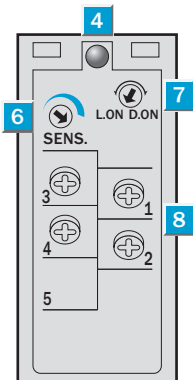

- 1** Middle of optic axis, receiver
- 2** Middle of optic axis, sender
- 3** Cable entry gland 1/2" PF thread for cable diameters from 6 to 10 mm optionally at bottom or rear; or M12 equipment plug, bottom
- 4** LED signal strength indicator, yellow, switching output active
- 5** Through hole \varnothing 5.2 mm on both sides for M5 hex nut
- 6** Scanning distance adjuster
- 7** Light/dark rotary switch
L.ON = light-switching, D.ON = dark-switching
- 8** Terminals

Connection Types

WT 260-F 280	WT 260-F 480
WT 260-E 280	WT 260-E 480

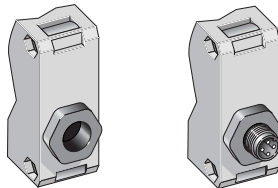

Terminals

4-pin, M12

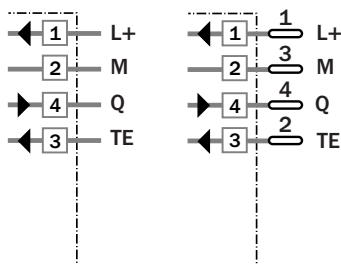

See chapter Accessories

Cables and connectors

Mounting systems^{*)}

^{*)} Mounting bracket included with delivery

Technical data		WT 260-	F 280	F 480	E 280	E 480
Scanning distance, typ. max.	10 to 3200 mm, adjustable ¹⁾					
Operating distance	15 to 2500 mm, adjustable ¹⁾					
Scanning distance setting	per potentiometer 270°					
Light source ²⁾	LED, infrared					
Light spot diameter	Approx. 80 mm at 2500 mm					
Aperture angle sender	Approx. 1.8°					
Supply voltage V_s	10 to 30 VDC ³⁾					
Ripple ⁴⁾	$\leq 5 V_{PP}$					
Current consumption ⁵⁾	$\leq 35 \text{ mA}$					
Switching outputs	PNP, open collector: Q NPN, open collector: Q					
Output current I_A max.	100 mA					
Light receiver, switching mode	Light-/dark-switching by rotary switch					
Response time ⁶⁾	$\leq 5.0 \text{ ms}$					
Switching frequency max. ⁷⁾	100/s					
Test input »TE« sender off	PNP: TE to + V_s NPN: TE to 0 V					
Connection types	Terminal chamber Plug M12, 4-pin					
VDE protection class ⁸⁾	<input type="checkbox"/>					
Circuit protection ⁹⁾	A, B, C, D					
Enclosure rating	IP 67					
Ambient temperature T_A	Operation $-25 \text{ }^\circ\text{C} \dots +55 \text{ }^\circ\text{C}$ Storage $-40 \text{ }^\circ\text{C} \dots +70 \text{ }^\circ\text{C}$					
Weight	Approx. 120 g					
Material	Housing: ABS; Optic: PC					

¹⁾ Object with 90 % remission (based on standard white DIN 5033)

²⁾ Average service life 100,000 h at $T_A = +25 \text{ }^\circ\text{C}$

³⁾ Limit values, operation in short circuit protected network max. 8 A

⁴⁾ Must be within V_s tolerances

⁵⁾ Without load

⁶⁾ With resistive load

⁷⁾ With light/dark ratio 1:1

⁸⁾ Reference voltage 50 V DC

⁹⁾ A = V_s connections reverse-polarity protected

B = Inputs/outputs reverse-polarity protected

C = Interference suppression

D = Outputs overcurrent and short-circuit protected

Scanning distance

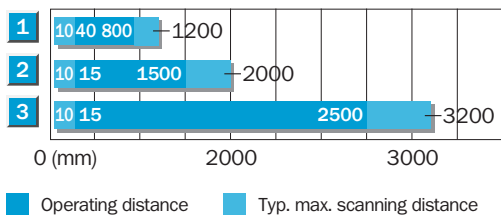

- 1 Scanning range on black, 6 % remission
- 2 Scanning range on grey, 18 % remission
- 3 Scanning range on white, 90 % remission

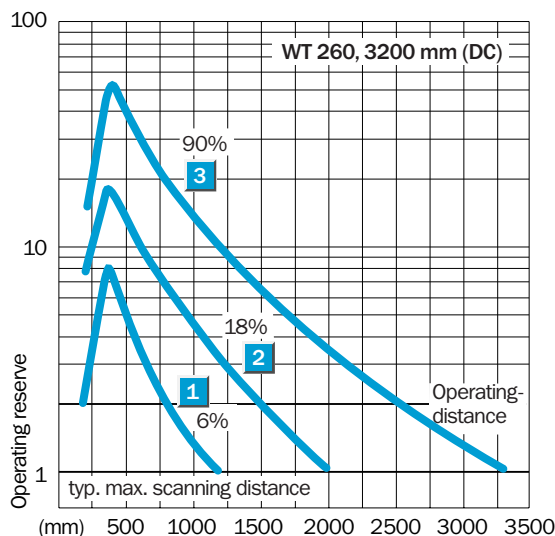

Order information

Type	Order no.
WT 260-F 280	6 020 982
WT 260-F 480	6 020 983
WT 260-E 280	6 020 984
WT 260-E 480	6 021 816

Scanning distance
10 ... 3500 mm
 Photoelectric proximity switch

- Universal voltage
- Infrared light, very high scanning distance
- Terminal chamber
- Relay output, SPDT, time delays
- CE generic emission standard EN 61000-6-3 (“Residential and Commercial Areas”)

Dimensional drawing

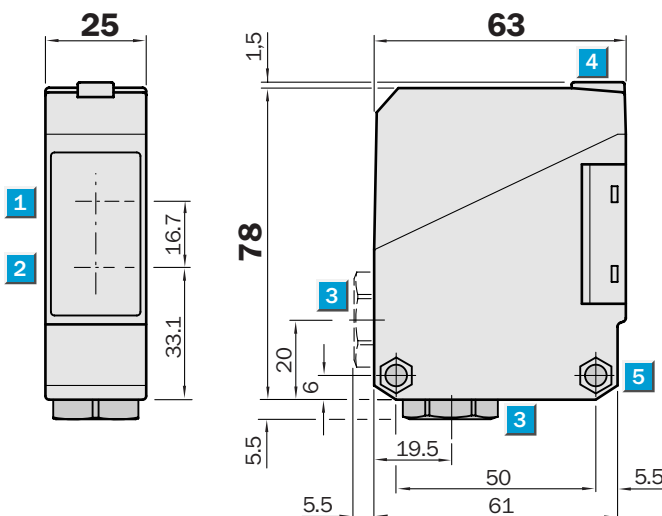

Adjustments possible

WT 260-S 280 WT 260-R 280

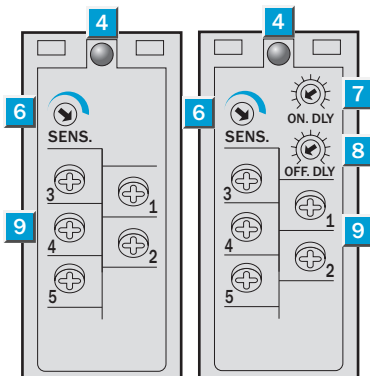

- 1 Middle of optic axis, receiver
- 2 Middle of optic axis, sender
- 3 Cable entry gland 1/2" PF thread for cable diameters from 6 to 10 mm optionally at bottom or rear
- 4 LED signal strength indicator, red
- 5 Through hole Ø 5.2 mm on both sides for M5 hex nut
- 6 Scanning distance adjuster
- 7 Time control ON delay t_{ON}
- 8 Time control OFF delay t_{OFF}
- 9 Terminals

Connection types

WT 260-S 280
WT 260-R 280

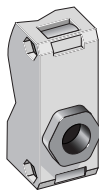

Terminals

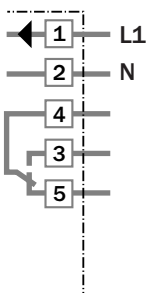

See chapter Accessories

Mounting systems^{*)}

^{*)} Mounting bracket included with delivery

Technical data		WT 260-	S 280	R 280								
Scanning distance, typ. max.	10 to 3500 mm, adjustable ¹⁾											
Operating distance	20 to 3000 mm, adjustable ¹⁾											
Scanning distance setting	per potentiometer 270°											
Light source²⁾	LED, infrared light											
Light spot diameter	Approx. 95 mm at 3000 mm											
Aperture angle sender	Approx. 1.7°											
Supply voltage V_s³⁾	12 to 240 V DC											
	24 to 240 V AC											
Power consumption	≤ 5 VA											
Switching output	Relay, SPDT, electrically isolated ⁴⁾											
Switching current I max	3 A/240 V AC; 3 A/30 V DC ⁵⁾											
Light receiver, switching mode	Light-switching											
Response time	≤ 20 ms											
Switching frequency max. ⁶⁾	25/s											
Time delays												
ON delay t _{ON}	0.1 to 10 s, can be connected separately											
OFF delay t _{OFF}	0.1 to 10 s, can be connected separately											
Connection type	Terminal chamber											
CE generic emission standard	Level EN 61000-6-3 ("Residential and Commercial Areas")											
VDE protection class⁷⁾	□											
Circuit protection⁸⁾	A, C											
Enclosure rating	IP 67											
Ambient temperature T_A	Operation -25 °C ... +55 °C Storage -40 °C ... +70 °C											
Weight	Approx. 120 g											
Material	Housing: ABS; Optics: PC											

¹⁾ Object with 90 % remission (based on standard white DIN 5033)
²⁾ Average service life 100,000 h at T_A = +25 °C

³⁾ ± 10 %
⁴⁾ Provide suitable spark suppression for inductive or capacitive loads

⁵⁾ Usage categorie to EN 60947-1, 15 AC, 13 DC
⁶⁾ With light/dark ratio 1:1
⁷⁾ Reference voltage 250 V UC

⁸⁾ A = V_s connections reverse-polarity protected
C = Interference suppression

Scanning distance

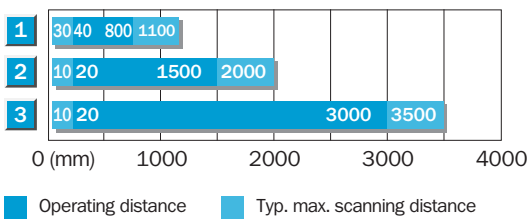

- 1 Scanning range on black, 6 % remission
- 2 Scanning range on grey, 18 % remission
- 3 Scanning range on white, 90 % remission

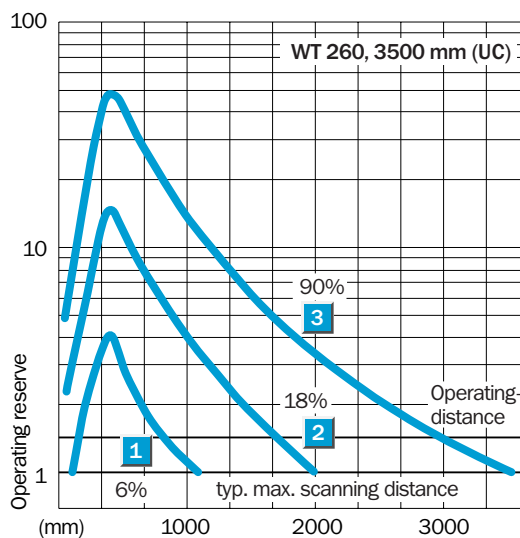

Order information

Type	Order no.
WT 260-S 280	6 020 771
WT 260-R 280	6 020 772

Scanning distance
 5 ... 1500 mm
 Photoelectric proximity switch

- Sensitivity, adjustable
- Terminal chamber or plug
M12, 4-pin
- Test input

Dimensional drawing

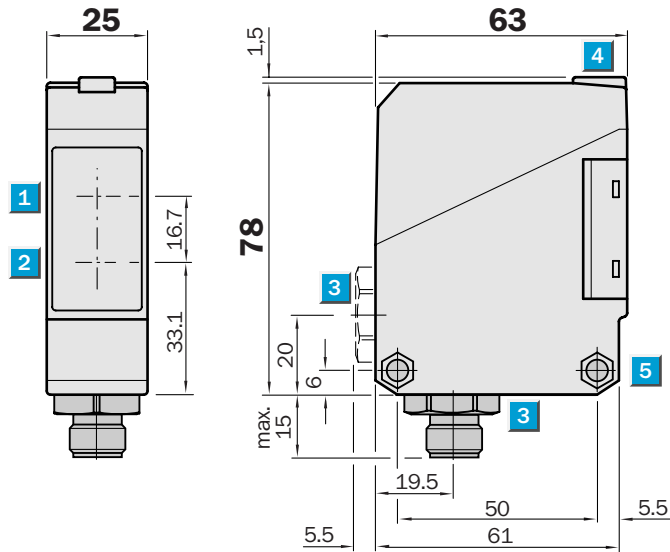

Adjustments possible

WT 260-F 270
WT 260-F 470
WT 260-E 270
WT 260-E 470

- 1 Middle of optic axis, receiver
- 2 Middle of optic axis, sender
- 3 Cable entry gland 1/2" PF thread for cable diameters from 6 to 10 mm optionally at bottom or rear; or M12 equipment plug, bottom
- 4 LED signal strength indicator, yellow, switching output active
- 5 Through hole \varnothing 5.2 mm on both sides for M5 hex nut
- 6 Scanning distance adjuster
- 7 Light/dark rotary switch
L.ON = light-switching, D.ON = dark-switching
- 8 Terminals

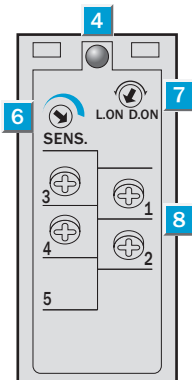

Connection types

WT 260-F 270	WT 260-F 470
WT 260-E 270	WT 260-E 470

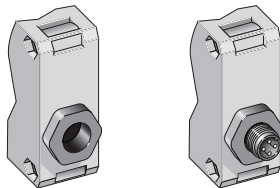

Terminals

4-pin, M12

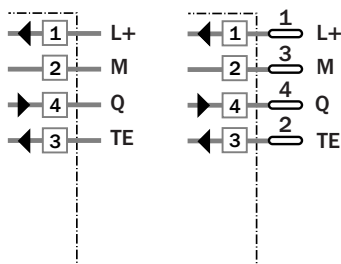

See chapter Accessories

Cables and connectors

Mounting systems^{*)}

^{*)} Mounting bracket included with delivery

Technical data		WT 260-	F 270	F 470	E 270	E 470
Scanning distance, typ. max.	15 to 1500 mm, adjustable ¹⁾					
Operating distance	5 to 1000 mm, adjustable ¹⁾					
Scanning distance setting	per potentiometer 270°					
Light source²⁾	LED, visible red light					
Light spot diameter	Approx. 45 mm at 1000 mm					
Aperture angle sender	Approx. 2.5°					
Supply voltage V_s	10 to 30 V DC ³⁾					
Ripple ⁴⁾	≤ 5 V _{pp}					
Current consumption ⁵⁾	≤ 35 mA					
Switching outputs	PNP, open collector: Q					
	NPN, open collector: Q					
Output current I _A max.	100 mA					
Light receiver, switching mode	Light-/dark-switching by rotary switch					
Response time ⁶⁾	≤ 0.5 ms					
Switching frequency max. ⁷⁾	1000/s					
Test input »TE« sender off	PNP: TE to + V _s					
	NPN: TE to 0 V					
Connection types	Terminal chamber					
	Plug M12, 4-pin					
VDE protection class⁸⁾	□					
Circuit protection⁹⁾	A, B, C, D					
Enclosure rating	IP 67					
Ambient temperature T_A	Operation - 25 °C ... + 55 °C					
	Storage - 40 °C ... + 70 °C					
Weight	Approx. 120 g					
Material	Housing: ABS; Optics: PC					

¹⁾ Object with 90 % remission (based on standard white DIN 5033)

²⁾ Average service life 100,000 h at T_A = + 25 °C

³⁾ Limit values, operation in short circuit protected network max. 8 A

⁴⁾ Must be within V_s tolerances

⁵⁾ Without load

⁶⁾ With resistive load

⁷⁾ With light/dark ratio 1:1

⁸⁾ Reference voltage 50 V DC

⁹⁾ A = V_s connections reverse-polarity protected

B = Inputs/outputs reverse-polarity protected

C = Interference suppression

D = Outputs overcurrent and short-circuit protected

Scanning distance

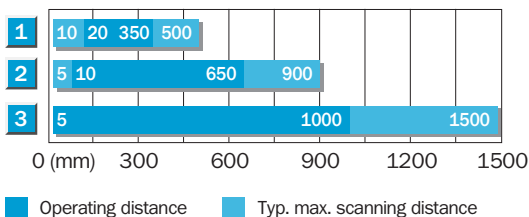

- 1 Scanning range on black, 6 % remission
- 2 Scanning range on grey, 18 % remission
- 3 Scanning range on white, 90 % remission

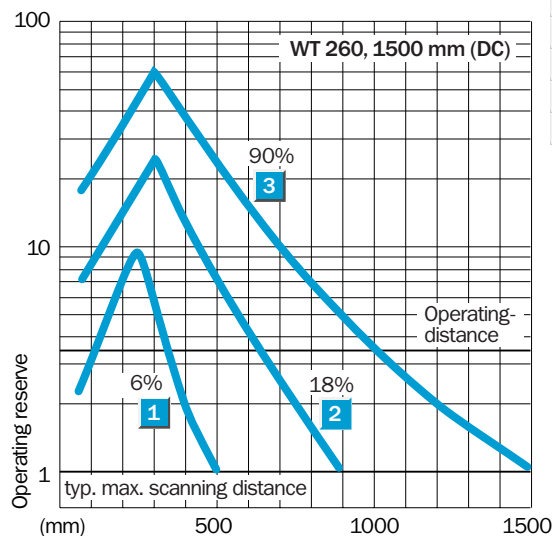

Order information

Type	Order no.
WT 260-F 270	6 020 979
WT 260-F 470	6 020 980
WT 260-E 270	6 020 981
WT 260-E 470	6 021 815

	Scanning distance 5 ... 1700 mm
Photoelectric proximity switch	

- Universal voltage
- Sensitivity, adjustable
- Terminal chamber
- Relay output, SPDT, time delays
- CE generic emission standard EN 61000-6-3 (“Residential and Commercial Areas”)

Dimensional drawing

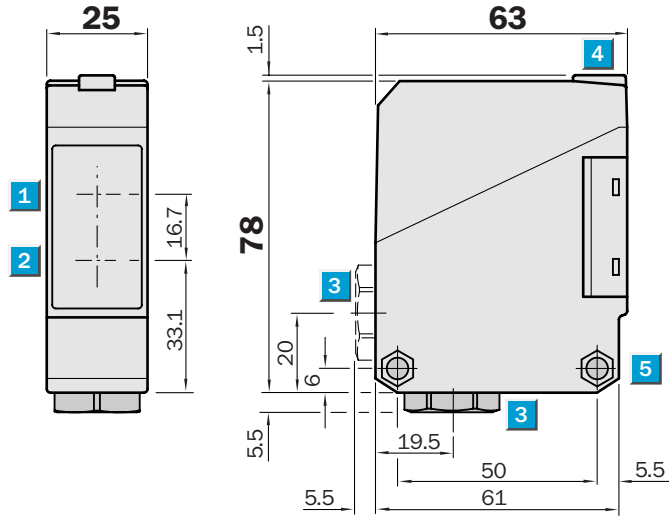

Adjustments possible

WT 260-S 270	WT 260-R 270
--------------	--------------

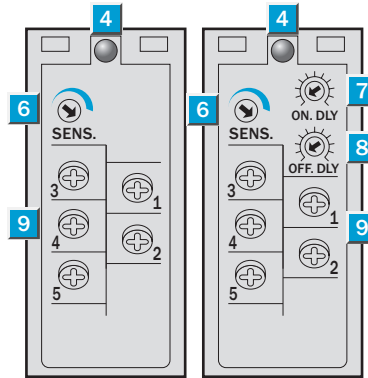

- 1 Middle of optic axis, receiver
- 2 Middle of optic axis, sender
- 3 Cable entry gland 1/2" PF thread for cable diameters from 6 to 10 mm optionally at bottom or rear
- 4 LED signal strength indicator, red
- 5 Through hole Ø 5.2 mm on both sides for M5 hex nut
- 6 Scanning distance adjuster
- 7 Time control ON delay t_{ON}
- 8 Time control OFF delay t_{OFF}
- 9 Terminals

Connection types

WT 260-S 270
WT 260-R 270

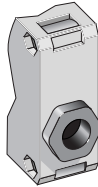
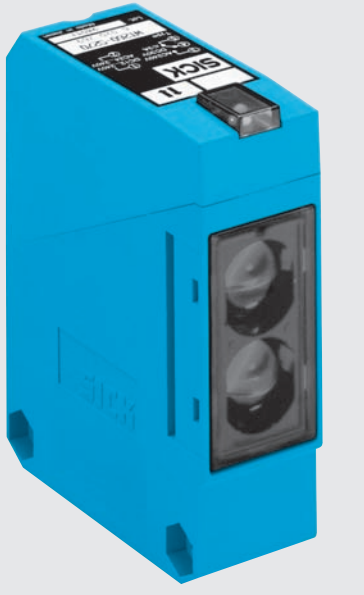

See chapter Accessories

Mounting systems^{*)}

^{*)} Mounting bracket included with delivery

Terminals

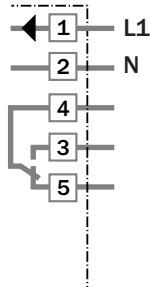

Technical data		WT 260-	S 270	R 270								
Scanning distance, typ. max.	5 to 1700 mm, adjustable ¹⁾											
Operating distance	5 to 1300 mm, adjustable ¹⁾											
Scanning distance setting	per potentiometer 270°											
Light source²⁾	LED, visible red light											
Light spot diameter	Approx. 60 mm at 1300 mm											
Aperture angle sender	Approx. 1.8°											
Supply voltage V_s³⁾	12 to 240 V DC											
	24 to 240 V AC											
Power consumption	≤ 5 VA											
Switching output	Relay, SPDT, electrically isolated ⁴⁾											
Switching current I max.	3 A/240 V AC; 3 A/30 V DC ⁵⁾											
Light receiver, switching mode	Light-switching											
Response time	≤ 20 ms											
Switching frequency max. ⁶⁾	25/s											
Time delay												
ON delay t _{ON}	0.1 to 10 s, can be connected separately											
OFF delay t _{OFF}	0.1 to 10 s, can be connected separately											
Connection type	Terminal chamber											
CE generic emission standard	Level EN 61000-6-3 ("Residential and Commercial Areas")											
VDE protection class⁷⁾	□											
Circuit protection⁸⁾	A, C											
Enclosure rating	IP 67											
Ambient temperature T_A	Operation - 25 °C ... + 55 °C Storage - 40 °C ... + 70 °C											
Weight	Approx. 120 g											
Material	Housing: ABS; Optics: PC											

¹⁾ Object with 90% remission (based on standard white DIN 5033)
²⁾ Average service life 100,000 h at T_A = + 25 °C

³⁾ ± 10 %
⁴⁾ Provide suitable spark suppression for inductive or capacitive loads

⁵⁾ Usage categorie to EN 60947-1, 15 AC, 13 DC
⁶⁾ With light/dark ratio 1:1
⁷⁾ Reference voltage 250 V UC

⁸⁾ A = V_s connections reverse-polarity protected
C = Interference suppression

Scanning distance

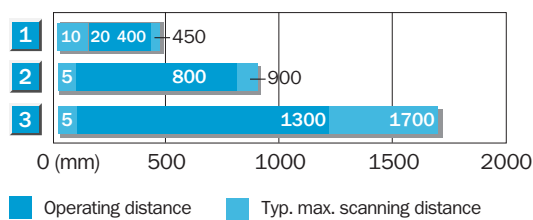

- 1 Scanning range on black, 6% remission
- 2 Scanning range on grey, 18% remission
- 3 Scanning range on white, 90% remission

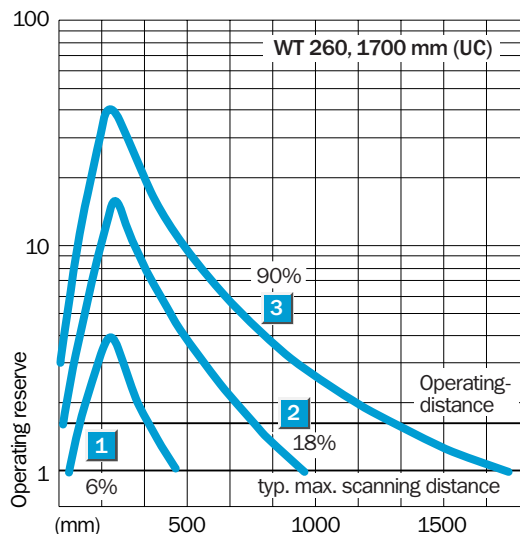

Order information

Type	Order no.
WT 260-S 270	6 020 769
WT 260-R 270	6 020 770

	Scanning range 0.01 ... 14 m
Photoelectric reflex switch	

- Polarizing filter providing reliable detection even of objects with shiny surfaces
- Sensitivity, adjustable
- Terminal chamber or plug M12, 4-pin
- Test input

Dimensional drawing

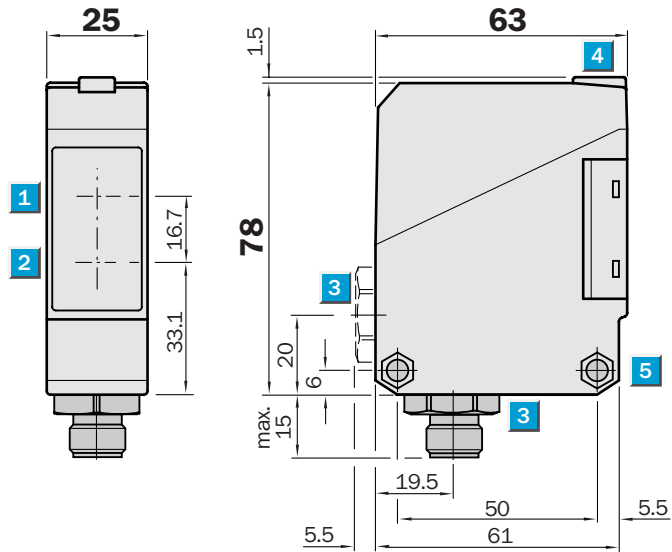

Adjustments possible

WL 260-F 270
WL 260-F 470
WL 260-E 270
WL 260-E 470

- 1 Middle of optic axis, receiver
- 2 Middle of optic axis, sender
- 3 Cable entry gland 1/2" PF thread for cable diameters from 6 to 10 mm optionally at bottom or rear; or M12 equipment plug, bottom
- 4 LED signal strength indicator, yellow, switching output active
- 5 Through hole Ø 5.2 mm on both sides for M5 hex nut
- 6 Sensitivity control
- 7 Light/dark rotary switch
L.ON = light-switching, D.ON = dark-switching
- 8 Terminals

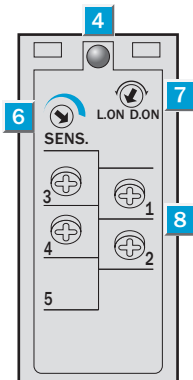

Connection types

WL 260-F 270	WL 260-F 470
WL 260-E 270	WL 260-E 470

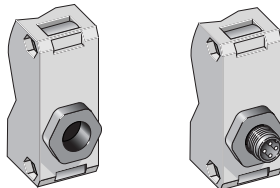

Terminals 4-pin, M12

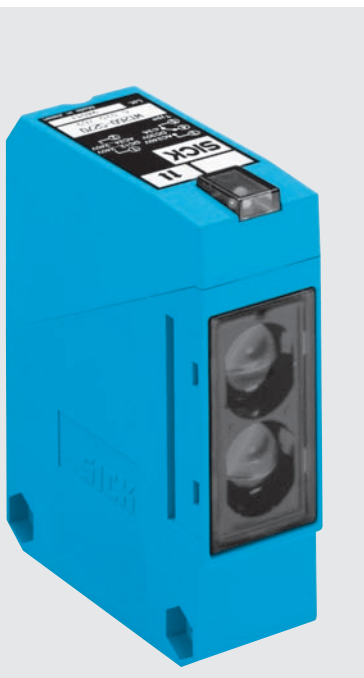
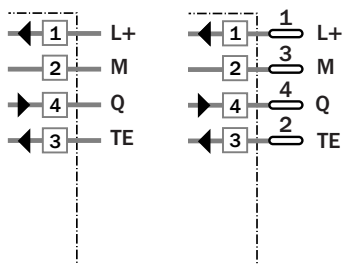

See chapter Accessories
Cables and connectors
Mounting systems*)
Reflectors**)

*) Mounting bracket included with delivery
 **) Reflector P 250 included with delivery

Technical data		WL 260-	F 270	F 470	E 270	E 470
Scanning range , typ. max/on reflector	0.01 to 14 m/PL 80 A					
	typ. max/on reflector	0.01 to 9.5 m/P 250 (included)				
Operating range	0.01 to 8 m/P 250					
Sensitivity	Adjustable, potentiometer 270°					
Light source ⁴⁾	LED, visible red light					
	With polarizing filter					
Light spot diameter	Approx. 240 mm at 8 m					
Aperture angle sender	Approx. 1.7°					
Supply voltage V _s	10 to 30 V DC ²⁾					
Ripple ³⁾	≤ 5 V _{PP}					
Current consumption ⁴⁾	≤ 35 mA					
Switching outputs	PNP, open collector: Q					
	NPN, open collector: Q					
Output current I _A max.	100 mA					
Light receiver, switching mode	Light-/dark-switching by rotary switch					
Response time ⁵⁾	≤ 1.5 ms					
Switching frequency max. ⁶⁾	333/s					
Test input »TE« sender off	PNP: TE to + V _s					
	NPN: TE to 0 V					
Connection types	Terminal chamber					
	Plug M12, 4-pin					
VDE protection class ⁷⁾	□					
Circuit protection ⁸⁾	A, B, C, D					
Enclosure rating	IP 67					
Ambient temperature T _A	Operation	-25 °C ... +55 °C				
	Storage	-40 °C ... +70 °C				
Weight	Approx. 120 g					
Material	Housing: ABS; Optics: PMMA					

1) Average service life 100,000 h at T_A = +25 °C
 2) Limit values, operation in short circuit protected network max. 8 A

3) Must be within V_s tolerances
 4) Without load
 5) With resistive load
 6) With light/dark ratio 1:1

7) Reference voltage 50 V DC
 8) A = V_s connections reverse-polarity protected
 B = Inputs/outputs reverse-polarity protected

C = Interference suppression
 D = Outputs overcurrent and short-circuit protected

Scanning range and operating reserve

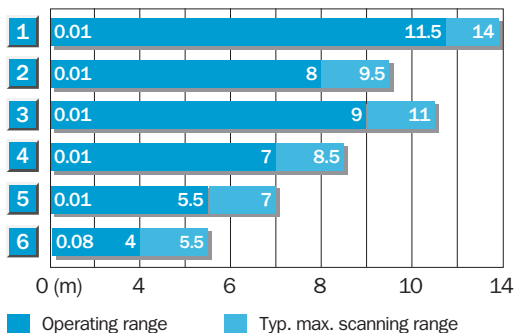

Reflector type	Operating range
1 PL 80 A	0.01 ... 11.5 m
2 P 250	0.01 ... 8 m
3 PL 50 A or PL 40 A	0.01 ... 9 m
4 PL 30 A or PL 31 A	0.01 ... 7 m
5 PL 20 A	0.01 ... 5.5 m
6 Reflective tape Diamond Grade	0.08 ... 4 m

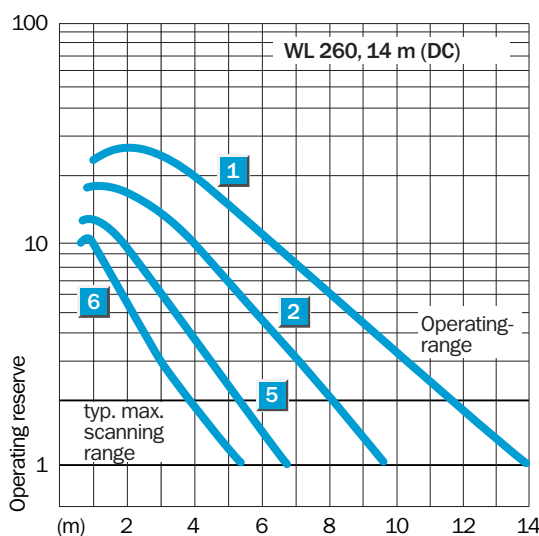

Order information

Type	Order no.
WL 260-F 270	6 020 976
WL 260-F 470	6 020 977
WL 260-E 270	6 020 978
WL 260-E 470	6 021 814

	Scanning range 0.01 ... 15 m
Photoelectric reflex switch	

- Universal voltage
- Polarizing filter providing reliable detection even of objects with shiny surfaces
- Terminal chamber
- Relay output, SPDT, time delays
- CE generic emission standard EN 61000-6-3 (“Residential and Commercial Areas”)

Dimensional drawing

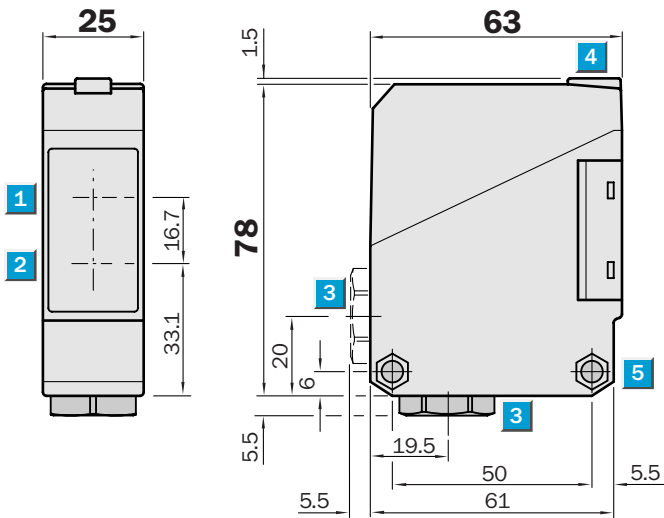

Adjustments possible

WL 260-S 270	WL 260-R 270
--------------	--------------

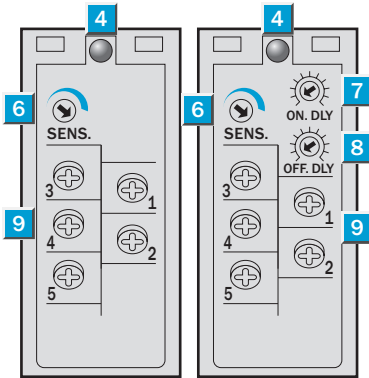

- 1 Middle of optic axis, receiver
- 2 Middle of optic axis, sender
- 3 Cable entry gland 1/2" PF thread for cable diameters from 6 to 10 mm optionally at bottom or rear
- 4 LED signal strength indicator, red
- 5 Through hole Ø 5.2 mm on both sides for M5 hex nut
- 6 Sensitivity control
- 7 Time control ON delay t_{ON}
- 8 Time control OFF delay t_{OFF}
- 9 Terminals

Connection types

WL 260-S 270
WL 260-R 270

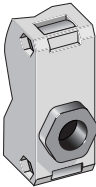

Terminals

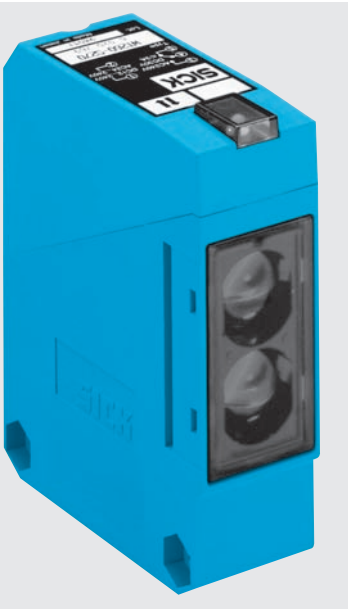
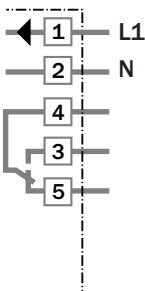

See chapter Accessories
 Mounting systems*)
 Reflectors **)

*) Mounting bracket included with delivery
 **) Reflector P 250 included with delivery

Technical data		WL 260-	S 270	R 270								
Scanning range , typ. max./on reflector	0.01 to 15 m/PL 80 A											
	typ. max./on reflector	0.01 to 11 m/P 250 (included)										
Operating range	0.01 to 10 m/P 250											
Sensitivity	Adjustable, potentiometer 270°											
Light source ⁴⁾	LED, visible red light											
	With polarizing filter											
Light spot diameter	Approx. 300 mm at 10 m											
Aperture angle sender	Approx. 1.7°											
Supply voltage V_S ²⁾	12 to 240 V DC											
	24 to 240 V AC											
Power consumption	≤ 5 VA											
Switching output	Relay, SPDT, electrically isolated ³⁾											
Switching current I max	3 A/240 V AC; 3 A/30 V DC ⁴⁾											
Light receiver, switching mode	Light-switching											
Response time	≤ 20 ms											
Switching frequency max. ⁵⁾	25/s											
Time delays												
ON delay t _{ON}	0.1 to 10 s, can be connected separately											
OFF delay t _{OFF}	0.1 to 10 s, can be connected separately											
Connection type	Terminal chamber											
CE generic emission standard	Level EN 61000-6-3 ("Residential and Commercial Areas")											
VDE protection class ⁶⁾	□											
Circuit protection ⁷⁾	A, C											
Enclosure rating	IP 67											
Ambient temperature T_A	Operation	-25 °C ... +55 °C										
	Storage	-40 °C ... +70 °C										
Weight	Approx. 120 g											
Material	Housing: ABS; Optics: PMMA											

¹⁾ Average service life 100,000 h at T_A = +25 °C

²⁾ ± 10 %

³⁾ Provide suitable spark suppression for inductive or capacitive loads

⁴⁾ Usage category to EN 60947-1, 15 AC, 13 DC

⁵⁾ With light/dark ratio 1:1

⁶⁾ Reference voltage 250 V UC

⁷⁾ A = V_s connections reverse-polarity protected
C = Interference suppression

Scanning range and operating reserve

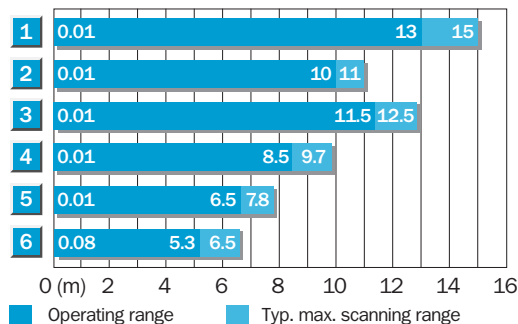

Reflector type	Operating range
1 PL 80 A	0.01 ... 13.0 m
2 P 250	0.01 ... 10.0 m
3 PL 50 A or PL 40 A	0.01 ... 11.5 m
4 PL 30 A or PL 31 A	0.01 ... 8.5 m
5 PL 20 A	0.01 ... 6.5 m
6 Reflective tape Diamond Grade	0.08 ... 5.3 m

05-08-2006

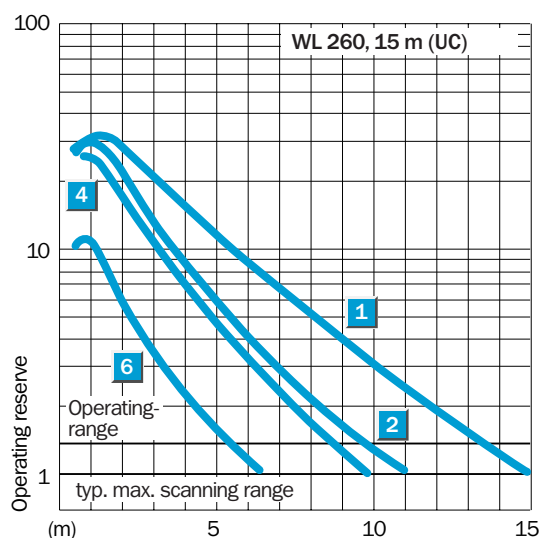

Order information

Type	Order no.
WL 260-S 270	6 020 767
WL 260-R 270	6 020 768

Scanning range
0 ... 35 m

Through-beam photoelectric switch

- Sensitivity, adjustable
- Terminal chamber or plug
M12, 4-pin
- Test input



Dimensional drawing

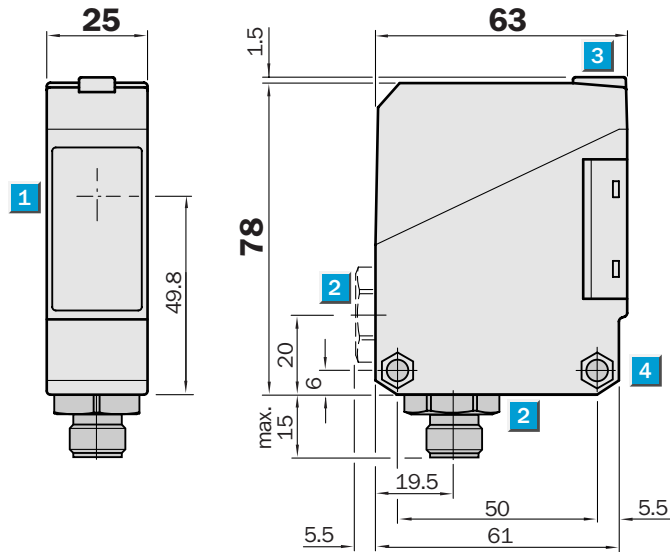

Adjustments possible

- WS/WE 260-F 270
- WS/WE 260-F 470
- WS/WE 260-E 270
- WS/WE 260-E 470

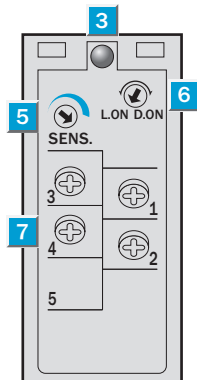

- 1** Middle of optic axis, sender/receiver
- 2** Cable entry gland 1/2" PF thread for cable diameters from 6 to 10 mm optionally at bottom or rear; or M12 equipment plug, bottom
- 3** LED signal indicator orange
WE 260: switching output active
WS 260: sender active
- 4** Through hole \varnothing 5.2 mm on both sides for M5 hex nut
- 5** Sensitivity control (WE 260)
- 6** Light/dark rotary switch (WE 260)
L.ON = light-switching, D.ON = dark-switching
- 7** Terminals
Terminal 3: WS 260 only
Terminal 4: WE 260 only

Connection types

- WS/WE 260-F 270
- WS/WE 260-F 470
- WS/WE 260-E 270
- WS/WE 260-E 470

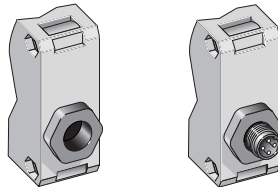

See chapter Accessories

- Cables and connectors
- Mounting systems*)
- Special accessories

*) Mounting bracket included with delivery

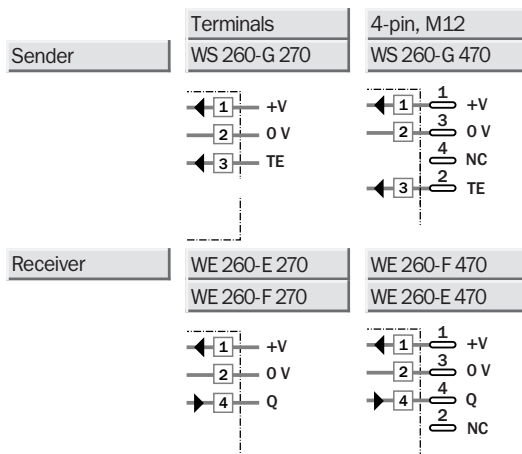

Technical data		WS/WE 260-	F 270	F 470	E 270	E 470						
Scanning range, typ. max.	0 ... 35 m											
Operating range	0 ... 30 m											
Sensitivity	Adjustable, potentiometer 270°											
Light source ¹⁾	LED, visible red light											
Light spot diameter	Approx. 700 mm at 30 m											
Aperture angle sender	Approx. 1.4°											
Angle of reception receiver	Approx. 20°											
Supply voltage V _s	10 to 30 V DC ²⁾											
Ripple ³⁾	≤ 5 V _{pp}											
Current consumption ⁴⁾												
sender	≤ 20 mA											
receiver	≤ 35 mA											
Switching outputs	PNP, open collector: Q NPN, open collector: Q											
Output current I _A max.	100 mA											
Light receiver, switching mode	Light-/dark-switching by rotary switch											
Response time ⁵⁾	≤ 1.5 ms											
Switching frequency max. ⁶⁾	333/s											
Test input »TE« sender off	PNP, NPN: TE to 0 V											
Connection types	Terminal chamber Plug M12, 4-pin											
VDE protection class ⁷⁾	□											
Circuit protection ⁸⁾												
sender	A, B											
receiver	A, B, C, D											
Enclosure rating	IP 67											
Ambient temperature T _A	Operation -25 °C ... +55 °C Storage -40 °C ... +70 °C											
Weight	Approx. 120 g											
Material	Housing: ABS; Optics: PC											

¹⁾ Average service life 100,000 h at T_A = +25 °C

²⁾ Limit values, operation in short circuit protected network max. 8 A

³⁾ Must be within V_s tolerances

⁴⁾ Without load

⁵⁾ With resistive load

⁶⁾ With light/dark ratio 1:1

⁷⁾ Reference voltage 50 V DC

⁸⁾ A = V_s connections reverse-polarity protected
B = Inputs/outputs reverse-polarity protected

C = Interference suppression
D = Outputs overcurrent and short-circuit protected

Operating range and operating reserve

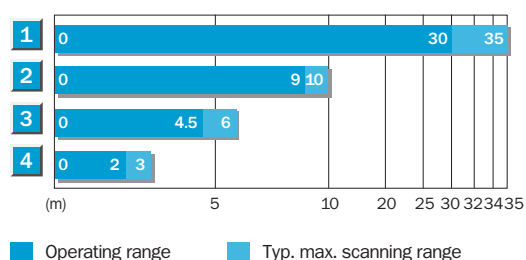

Scanning range reduction when using slotted masks	
1	Without slotted mask
2	Orifice width 5 mm
3	Orifice width 2 mm
4	Orifice width 1 mm

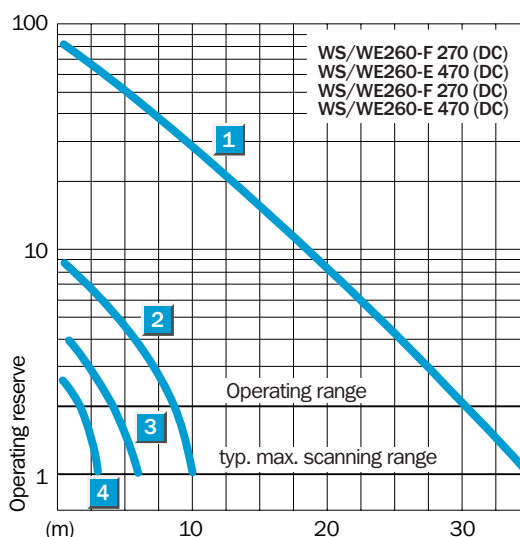

Order information

Type	Order no.
WS/WE 260-F 270	6 020 973
WS/WE 260-F 470	6 020 974
WS/WE 260-E 270	6 020 975
WS/WE 260-E 470	6 021 817

 **Scanning range**
0 ... 45 m

Through-beam photoelectric switch

- Universal voltage
- Sensitivity, adjustable
- Terminal chamber
- Relay output, SPDT, time delays
- CE generic emission standard EN 61000-6-3 (“Residential and Commercial Areas”)

Dimensional drawing

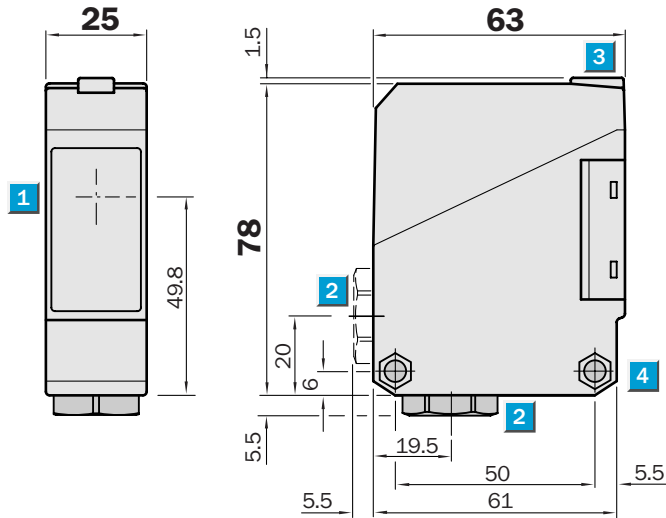

Adjustments possible

WS/WE 260-S 270 WS/WE 260-R 270

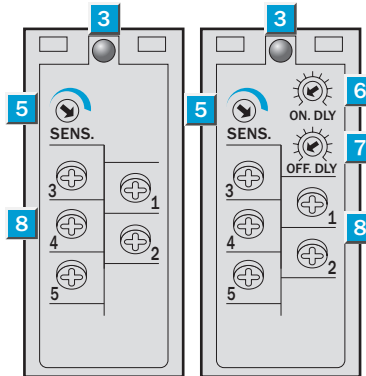

- 1 Middle of optic axis, sender resp. receiver
- 2 Cable entry gland 1/2" PF thread for cable diameters from 6 to 10 mm optionally at bottom or rear
- 3 LED signal indicator orange; WE 260: switching output active WS 260: sender active
- 4 Through hole Ø 5.2 mm on both sides for M5 hex nut
- 5 Sensitivity control (WE 260)
- 6 Time control ON delay t_{ON} (WE 260)
- 7 Time control OFF delay t_{OFF} (WE 260)
- 8 Terminals 3, 4, 5: WE 260 only



Connection types

WS/WE 260-S 270
WS/WE 260-R 270

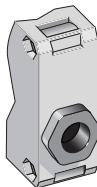

See chapter Accessories

Mounting systems*)
Special accessories

*) Reflector P 250 included with delivery

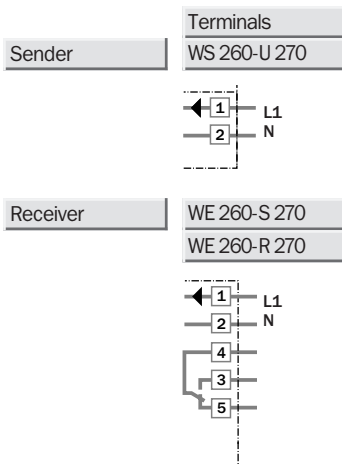

Technical data		WS/WE 260-	S 270	R 270								
Scanning range , typ. max.	0 ... 45 m											
Operating range	0 ... 40 m											
Sensitivity	Adjustable, potentiometer 270°											
Light source ¹⁾	LED, visible red light											
Light spot diameter	Approx. 700 mm at 40 m											
Aperture angle sender	Approx. 1°											
Angle of reception receiver	Approx. 20°											
Supply voltage V _S ²⁾	12 to 240 V DC 24 to 240 V AC											
Power consumption												
Sender	≤ 4 VA											
Receiver	≤ 5 VA											
Switching output	Relay, SPDT, electrically isolated ³⁾											
Switching current I max.	3 A/240 V AC; 3 A/30 V DC ⁴⁾											
Light receiver, switching mode	Light-switching											
Response time	≤ 20 ms											
Switching frequency max. ⁵⁾	25/s											
Time delays												
ON delay t _{ON}	0.1 to 10 s, can be connected separately											
OFF delay t _{OFF}	0.1 to 10 s, can be connected separately											
Connection type	Terminal chamber											
CE generic emission standard	Level EN 61000-6-3 ("Residential and Commercial Areas")											
VDE protection class ⁶⁾	□											
Circuit protection ⁷⁾	A, C											
Enclosure rating	IP 67											
Ambient temperature T _A	Operation -25 °C ... +55 °C Storage -40 °C ... +70 °C											
Weight	Approx. 120 g											
Material	Housing: ABS; Optics: PC											

¹⁾ Average service life 100,000 h at T_A = + 25 °C

²⁾ ± 10 %

³⁾ Provide suitable spark suppression for inductive or capacitive loads

⁴⁾ Usage categorie to EN 60947-1, 15 AC, 13 DC

⁵⁾ With light/dark ratio 1:1

⁶⁾ Reference voltage 250 V UC

⁷⁾ A = V_S connections reverse-polarity protected

C = Interference suppression

Operating range and operating reserve

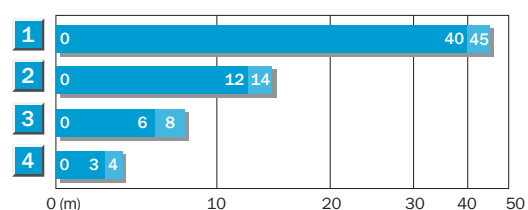

■ Operating range ■ Typ. max. scanning range

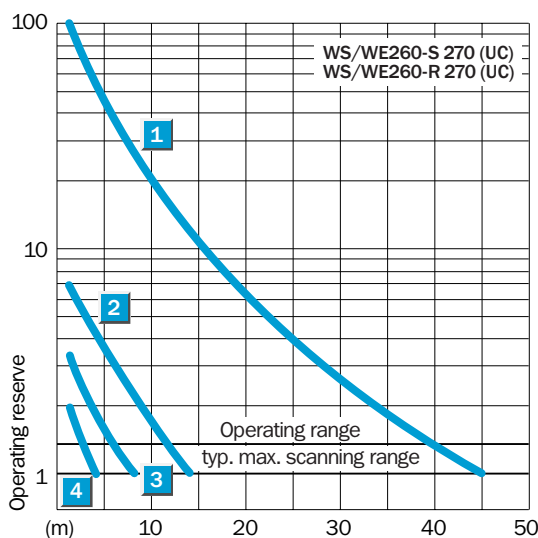

Scanning range reduction when using slotted masks

1	Without slotted mask
2	Slot width 5 mm
3	Slot width 2 mm
4	Slot width 1 mm



Order information

Type	Order no.
WS/WE 260-S 270	6 020 773
WS/WE 260-R 270	6 020 774

	Scanning range max. 800 mm
Through-beam systems	
	Scanning distance max. 65 (110) mm
Proximity systems	

- Broad range of fibre-optic cables for through-beam and proximity applications
- Easy adaption of fibre-optic cable using cap nut
- Sensitivity, adjustable
- Terminal chamber, at bottom and rear or plug M12, 4-pin
- Test input

Dimensional drawing

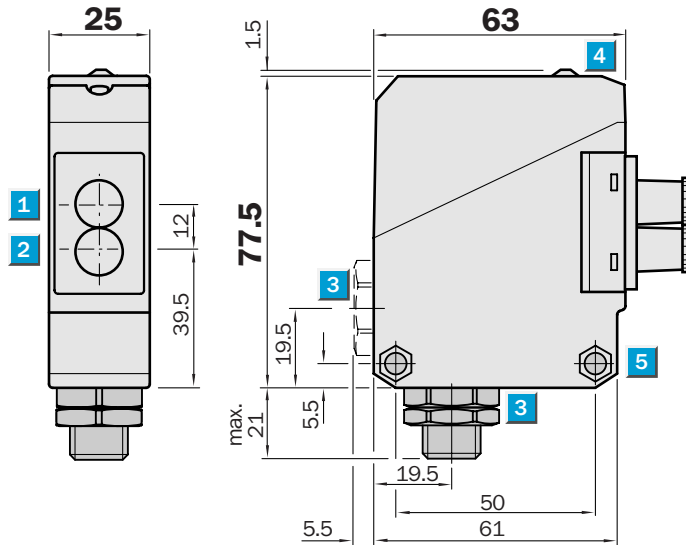

Adjustments possible

WLL 260-F 240
WLL 260-F 440
WLL 260-E 240

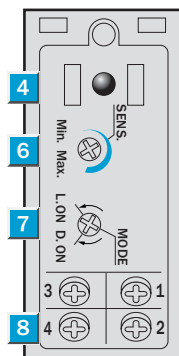

- 1** Middle of optic axis, receiver
- 2** Middle of optic axis, sender
- 3** Cable entry gland 1/2" PF thread for cable diameters from 6 to 10 mm optionally at bottom or rear; or M12 equipment plug, bottom
- 4** LED signal strength indicator, red
- 5** Through hole Ø 5.2 mm on both sides for M5 hex nut
- 6** Sensitivity control
- 7** Light/dark rotary switch
L.ON = light-switching, D.ON = dark-switching
- 8** Terminals

Connection types

WLL 260-E 240	WLL 260-F 440
WLL 260-F 240	

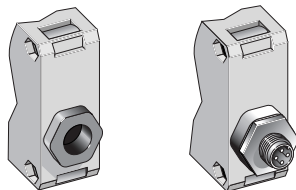

Terminals 4-pin, M12

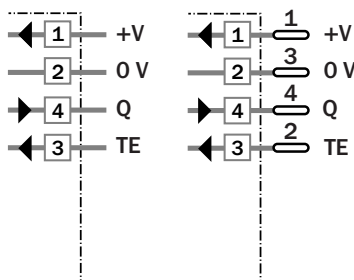

See chapter Accessories
Cables and connectors
Mounting systems*)
Fibre-optic cables

*) Mounting bracket included with delivery

Technical data		WLL 260-	F 240	F 440	E 240						
Suitable fibre-optic cable	Fibre-optic cable series LIS/LBS										
Scanning distance/range	Depends on the fibre-optic cable used										
Proximity system											
Typ. max. scanning distance ¹⁾	0 to 65 mm										
	0 to 110 mm with special fibre-optic cable										
Operating distance ¹⁾	0 to 50 mm										
	0 to 90 mm with special fibre-optic cable										
Through-beam system											
Typ. max. scanning range	0 to 800 mm										
Operating range	0 to 700 mm										
Sensitivity	Adjustable, potentiometer 270°										
Light source ²⁾	LED, visible red light										
Light spot diameter	Depends on scanning range										
Aperture fibre-optic cable	Approx. 65°										
Supply voltage V_S	10 to 30 V DC ³⁾										
Ripple ⁴⁾	≤ 5 V _{PP}										
Current consumption ⁵⁾	≤ 35 mA										
Switching outputs	PNP, open collector: Q										
	NPN, open collector: Q										
Output current I _A max.	100 mA										
Light receiver, switching mode	Light-/dark-switching by rotary switch										
Response time ⁶⁾	≤ 0.7 ms										
Switching frequency max. ⁷⁾	700/s										
Test input »TE« sender off	PNP: TE following + V _S										
	NPN: TE following 0 V										
Connection types	Terminal chamber										
	Plug M12, 4-pin										
VDE protection class ⁸⁾	□										
Circuit protection ⁹⁾	A, B, C, D										
Enclosure rating	IP 66										
Ambient temperature T_A	Operation -25 °C ... +55 °C										
	Storage -40 °C ... +70 °C										
Weight	Approx. 120 g										
Material	Housing: ABS										

¹⁾ Object with 90 % remission (based on standard white DIN 5033)
²⁾ Average service life 100,000 h at T_A = +25 °C

³⁾ Limit values, operation in short circuit protected network max. 8 A
⁴⁾ Must be within V_S tolerances
⁵⁾ Without load
⁶⁾ With resistive load

⁷⁾ With light/dark ratio 1:1
⁸⁾ Reference voltage 50 V DC
⁹⁾ A = V_S connections reverse-polarity protected

B = Inputs/outputs reverse-polarity protected
 C = Interference suppression
 D = Outputs overcurrent and short-circuit protected

Order information	
Type	Order no.
WLL 260-F 240	6 020 064
WLL 260-F 440	6 020 065
WLL 260-E 240	6 020 063

	Scanning range max. 800 mm
Through-beam systems	
	Scanning distance max. 65 (110) mm
Proximity systems	

- Universal voltage
- Broad range of fibre-optic cables for through-beam and proximity applications
- Easy adaption of fibre-optic cable using cap nut
- Sensitivity, adjustable
- Terminal chamber
- Relay output, SPDT, time delays



Dimensional drawing

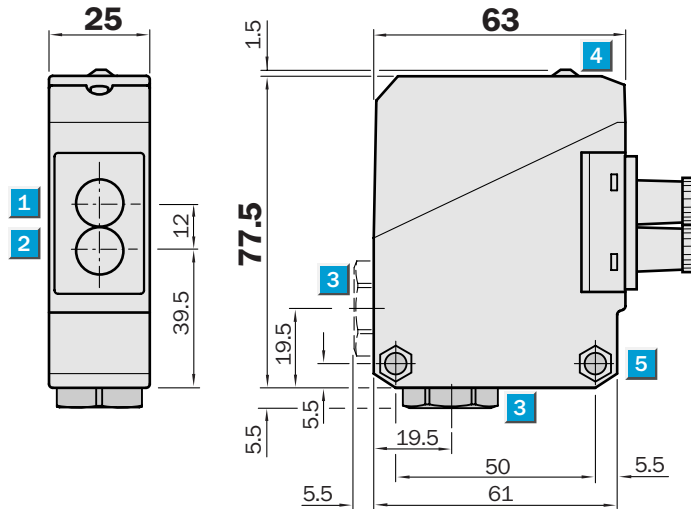

Adjustments possible

WLL 260-S 240	WLL 260-R 240
---------------	---------------

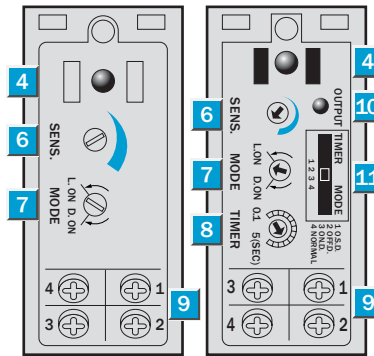

- 1 Middle of optic axis, receiver
- 2 Middle of optic axis, sender
- 3 Cable entry gland 1/2" PF thread for cable diameters from 6 to 10 mm optionally at bottom or rear
- 4 LED signal strength indicator, red
- 5 Through hole Ø 5.2 mm on both sides for M5 hex nut
- 6 Sensitivity control
- 7 Light/dark rotary switch
L.ON = light-switching, D.ON = dark-switching
- 8 Time range control
- 9 Terminals
- 10 Red LED status indicator, switching output active
- 11 Time delay selector switch
O.S.D. = One Shot
OFF.D. = OFF delay
ON.D. = ON delay
Normal = No delay

Connection types

WLL 260-S 240
WLL 260-R 240

Time delays

t = 0.1–5 s

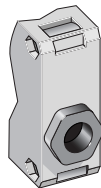

Terminals

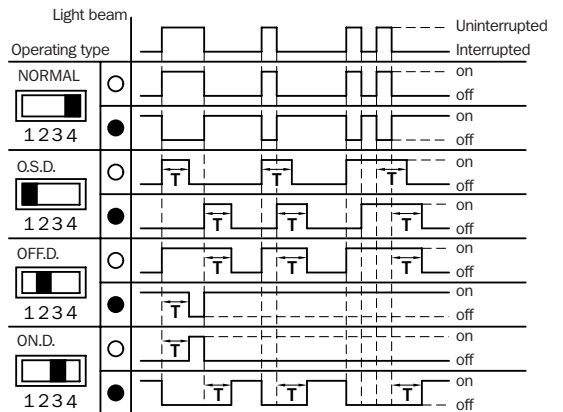
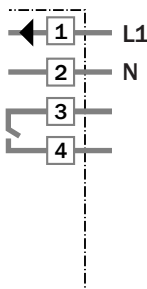

See chapter Accessories

- Mounting systems*)
- Fibre-optic cables

*) Mounting bracket included with delivery

Technical data		WLL 260-	S 240	R 240								
Suitable fibre-optic cable	Fibre-optic cable series LIS/LBS											
Scanning distance/range	Depends on the fibre-optic cable used											
Proximity system												
Typ. max. scanning distance ¹⁾	0 to 65 mm											
	0 to 110 mm with special fibre-optic cable											
Operating distance ¹⁾	0 to 50 mm											
	0 to 90 mm with special fibre-optic cable											
Through-beam system												
Typ. max. scanning range	0 to 800 mm											
Operating range	0 to 700 mm											
Sensitivity	Adjustable, potentiometer 270°											
Light source ²⁾	LED, visible red light											
Light spot diameter	Depends on scanning range											
Aperture fibre-optic cable	Approx. 65°											
Supply voltage V_s ³⁾	12 to 240 V DC											
	24 to 240 V AC											
Power consumption	≤ 5 VA											
Switching output	Relay, SPDT, electrically isolated ⁴⁾											
Switching current I max.	3 A/240 V AC; 3 A/30 V DC ⁵⁾											
Light receiver, switching mode	Light-/dark-switching by rotary switch											
Response time	≤ 20 ms											
Switching frequency max. ⁶⁾	25/s											
Time delays	With indicator LED: Switching output active											
Switch position	"1 O.S.D."	"One shot"										
	"2 OFF.D."	OFF delay t _{OFF}										
	"3 ON.D."	ON delay t _{ON}										
	"4 Normal"	No delay										
Time range	Adjustable, 0.1 to 5 s; potentiometer 270°											
Connection type	Terminal chamber											
VDE protection class ⁷⁾	□											
Circuit protection ⁸⁾	A, C											
Enclosure rating	IP 66											
Ambient temperature T_A	Operation -25 °C ... +55 °C											
	Storage -40 °C ... +70 °C											
Weight	Approx. 120 g											
Material	Housing: ABS											

¹⁾ Object with 90 % remission (based on standard white DIN 5033)

²⁾ Average service life 100,000 h at T_A = +25 °C

³⁾ ± 10 %

⁴⁾ Provide suitable spark suppression for inductive or capacitive loads

⁵⁾ Usage categorie to EN 60947-1, 15 AC, 13 DC

⁶⁾ With light/dark ratio 1:1

⁷⁾ Reference voltage 50 V DC

⁸⁾ A = V_s connections reverse-polarity protected

C = Interference suppression

Order information

Type	Order no.
WLL 260-S 240	6 009 504
WLL 260-R 240	6 009 503