

JUMO GmbH & Co. KG
Delivery address: Mackenrodtstraße 14,
36039 Fulda, Germany
Postal address: 36035 Fulda, Germany
Phone: +49 661 6003-0
Fax: +49 661 6003-607
e-mail: mail@jumo.net
Internet: www.jumo.net

JUMO Instrument Co. Ltd.
JUMO House
Temple Bank, Riverway
Harlow, Essex CM 20 2TT, UK
Phone: +44 1279 635533
Fax: +44 1279 635262
e-mail: sales@jumo.co.uk
Internet: www.jumo.co.uk

JUMO Process Control, Inc.
8 Technology Boulevard
Canastota, NY 13031, USA
Phone: 315-697-JUMO
1-800-554-JUMO
Fax: 315-697-5867
e-mail: info@jumo.us
Internet: www.jumo.us



Resistance thermometers for the food and pharmaceutical industries

- for temperatures from -50 to +250°C
- EHEDG certification
- stainless steel protection tubes
- with optional 2-wire transmitter
- CIP-compliant installation

The resistance thermometers can optionally be provided with terminal heads in stainless steel, aluminium die-casting, or plastic.

To suit the specific needs of the different sectors of the food and pharmaceutical industries, a wide variety of process connections can be supplied: from G 1/2 (1/2" pipe) screw fittings with CIP-compliant sealing cone, through taper nipples with ring nut (milk pipe fitting), and clamping nipples, to sliding ball weld-in sockets, weld-in sockets, Varivent connections, and ball weld-in pockets. The protection tubes are made from stainless steel.

The resistance thermometers for the food and pharmaceutical industries are suitable for the temperature range from -50 to +250°C.

Pt100 single and twin temperature sensors to EN 60 751, Class A, in 3-wire circuit ensure the highest degree of accuracy.

For longer transmission distances, analog or programmable 2-wire transmitters are optionally available.

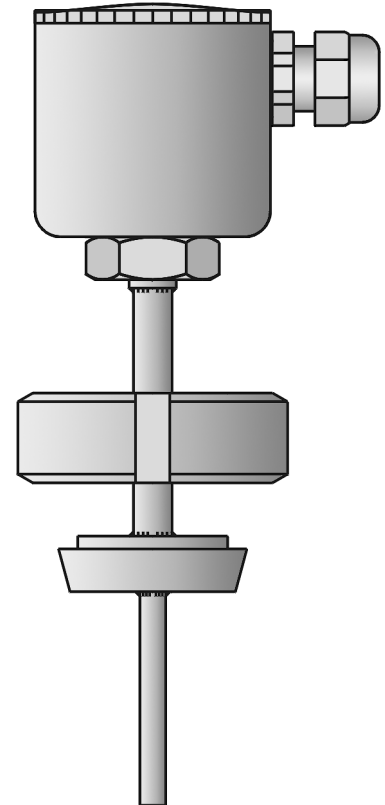

Technical data

Terminal head

stainless steel 1.4571, M 16x1.5; IP67, ambient temperature -20 to +100°C
Form B DIN 43 729, aluminium die-casting, M 20x1.5; IP54, ambient temperature -40 to +100°C
Form BUZ, aluminium die-casting, M 20x1.5; IP65, ambient temperature -40 to +100°C
Form BUZH, aluminium die-casting, M 20x1.5; IP65, ambient temperature -40 to +100°C
Form BBKS, plastic (PA 6), M 20x1.5; IP54, ambient temperature -30 to +130°C
Caution: reduced ambient temperature when using transmitters;
data sheet 70.7010/70.7030

Extension tube

stainless steel, approx. 70mm long, 9mm dia.

Process connection

screw fitting with CIP-compliant sealing cone, stainless steel 316 L, with EHEDG certification
clamping nipple to DIN 32 676, stainless steel 316 L
clamping nipple with ring nut (milk pipe fitting) to DIN 11 851, stainless steel 316 L
ball weld-in socket, stainless steel 316 L, clamping ring in PTFE
CIP-compliant weld-in socket, stainless steel 316 L, seal in PTFE
Varivent connection, stainless steel 316 L
ball weld-in pocket, stainless steel 316 Ti
JUMO PEKA process connection adapter, stainless steel 316 L, with EHEDG certification

Protection tube

stainless steel 316 L, 6mm dia.
stainless steel 316 Ti, on request

Measuring insert

Pt100 temperature sensor to EN 60 751, Class A, 3-wire circuit

Response times

$t_{0,9} = 10\text{sec}$, in water 0.4m/sec, 6mm dia.

Transmitter

analog transmitter, output 4 – 20mA, data sheet 70.7030
analog transmitter, output 0 – 10V, data sheet 70.7030
programmable transmitter, output 4 – 20mA/20 – 4mA, data sheet 70.7010

JUMO GmbH & Co. KG
 Delivery address: Mackenrodtstraße 14,
 36039 Fulda, Germany
 Postal address: 36035 Fulda, Germany
 Phone: +49 661 6003-0
 Fax: +49 661 6003-607
 e-mail: mail@jumo.net
 Internet: www.jumo.net

JUMO Instrument Co. Ltd.
 JUMO House
 Temple Bank, Riverway
 Harlow, Essex CM 20 2TT, UK
 Phone: +44 1279 635533
 Fax: +44 1279 635262
 e-mail: sales@jumo.co.uk
 Internet: www.jumo.co.uk

JUMO Process Control, Inc.
 8 Technology Boulevard
 Canastota, NY 13031, USA
 Phone: 315-697-JUMO
 1-800-554-JUMO
 Fax: 315-697-5867
 e-mail: info@jumo.us
 Internet: www.jumo.us



Dimensions

Possible variants

Screw fitting with
 CIP-compliant conical seal

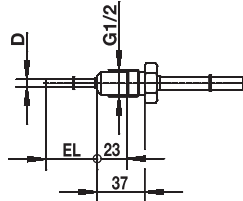

Clamping nipple to DIN 32676

DN	D1	DN	D1
-	Ø25	40/1,5"	Ø50,5
10/20	Ø34	50/2"	Ø64
25/1"	Ø50,5	2,5"	Ø77,5

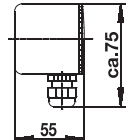
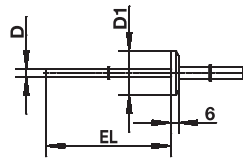

Stainless steel
 terminal head KGI-1

Ball weld-in socket
 with clamping thread

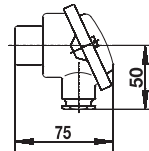
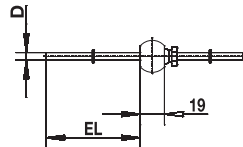

Aluminium die-casting
 terminal head Form B

Taper nipple with ring nut
 to DIN 11851
 (milk pipe fitting)

DN	D1	D2	D3	D4	L1	L2
10	Ø22	Ø18	RD 28x1/8	Ø38	9	18
25	Ø44	Ø35	RD 52x1/8	Ø63	13	21
32	Ø50	Ø41	RD 58x1/8	Ø70		

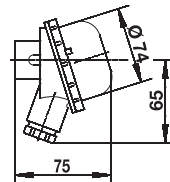
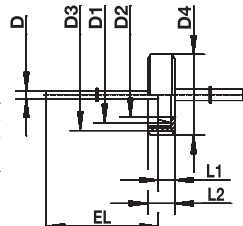

Plastic
 terminal head Form BBKS

Weld-in socket
 with CIP-compliant sealing system

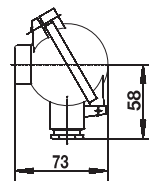
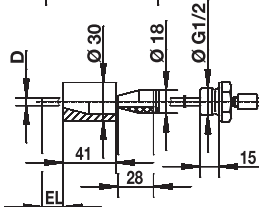

Aluminium die-casting
 terminal head Form BUZ

Varivent connection

DN	D1
15/10	Ø31
32/25	Ø50
50/40	Ø68

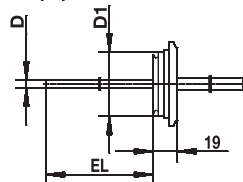

Ball weld-in pocket

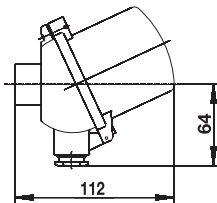
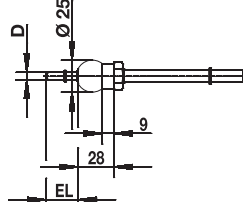

Aluminium die-casting
 terminal head Form BUZH

JUMO PEKA
 Process connection adapter
 as per data sheet 40,9711

Varivent	Clamp	Aseptic	Weld-in socket
DN 25/32	DN 25/32/40	DN 40	Ø 55 mm
DN 40-125	DN 50	DN 50	
		NKS DN 40	

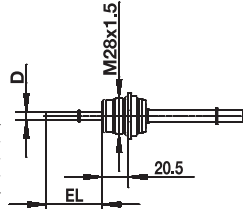

JUMO GmbH & Co. KG
 Delivery address: Mackenrodtstraße 14,
 36039 Fulda, Germany
 Postal address: 36035 Fulda, Germany
 Phone: +49 661 6003-0
 Fax: +49 661 6003-607
 e-mail: mail@jumo.net
 Internet: www.jumo.net

JUMO Instrument Co. Ltd.
 JUMO House
 Temple Bank, Riverway
 Harlow, Essex CM 20 2TT, UK
 Phone: +44 1279 635533
 Fax: +44 1279 635262
 e-mail: sales@jumo.co.uk
 Internet: www.jumo.co.uk

JUMO Process Control, Inc.
 8 Technology Boulevard
 Canastota, NY 13031, USA
 Phone: 315-697-JUMO
 1-800-554-JUMO
 Fax: 315-697-5867
 e-mail: info@jumo.us
 Internet: www.jumo.us



Order details: Resistance thermometers for the food and pharmaceutical industries

(1) Basic type

	902810/13	Resistance thermometer with terminal head Form B
	902810/20	Resistance thermometer with terminal head in stainless steel
	(2) Measuring insert	
x x	1001	1 x Pt100 in 3-wire circuit
x x	2001	2 x Pt100 in 3-wire circuit
	(3) Tolerance class to EN 60 751	
x x	2	Class A (standard)
x x	3	Class 1/3 DIN
	(4) Protection tube diameter D in mm	
x x	6	6mm
	(5) Fitting length EL in mm (25 ≤ EL ≤ 400)	
x x	25	25mm
x x	50	50mm
x x	100	100mm
x x	150	150mm
x x	...	please specify in plain text (50mm steps)
	(6) Process connection	
x x	104	G 1/2 (1/2" pipe) thread
x x	380	G 1/2 (1/2" pipe) thread with CIP-compliant conical seal, with EHEDG certification
x x	601	taper nipple with ring nut DN10 to DIN 11 851 (milk pipe fitting)
x x	604	taper nipple with ring nut DN25 to DIN 11 851 (milk pipe fitting)
x x	605	taper nipple with ring nut DN32 to DIN 11 851 (milk pipe fitting)
x x	611	clamping nipple DN 10/20 to DIN 32 676
x x	613	clamping nipple DN 25/40 (1"/1.5") to DIN 32 676
x x	616	clamping nipple DN 50 (2") to DIN 32 676
x x	617	clamping nipple 2.5" similar to DIN 32 676
x x	681	ball weld-in socket with clamping thread
x x	682	weld-in socket with CIP-compliant sealing system
x x	684	Varivent connection DN 15/10
x x	685	Varivent connection DN 32/25
x x	686	Varivent connection DN 50/40
x x	840	ball weld-in pocket (material 316 Ti)
x x	997	JUMO PEKA with EHEDG certification ⁴
	(7) Protection tube material	
x x	24	stainless steel 316 L (Mat. Ref. 1.4404 / 1.4435)
x x	26	stainless steel 316 Ti (Mat. Ref. 1.4571) (on request)
	(8) Extra codes	
x x	000	no extra code
x x	305	without extension (only for process connection 104 and 380)
x	320	terminal head Form BUZ
x	321	terminal head Form BUZH
x	324	terminal head Form BBKS
x x	330	1 x analog transmitter, output 4 – 20mA ² , data sheet 70.7030
x x	331	1 x programmable transmitter, output 4 – 20mA/20 – 4mA ³ , data sheet 70.7010
x x	333	1 x analog transmitter, output 0 – 10V ² , data sheet 70.7030
x x	365	acceptance test certificate 3.1B EN 10 204: insulation resistance
x x	367	acceptance test certificate 3.1B EN 10 204: pressure test
x x	368	acceptance test certificate 3.1B EN 10 204: leakage test
x x	374	acceptance test certificate 3.1B EN 10 204: material
x x	452	parts in contact with the medium electrolytically polished, surface roughness Ra ≤ 0.8µm (not for process connection 104, 681, 682 and 840)
x x	810	weld-in socket (only for process connection 380)

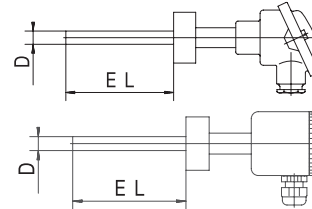

Order code (1) (2) (3) (4) (5) (6) (7) (8) ,...

Order example 902810/13 - 1001 - 2 - 6 - 100 - 380 - 24 / 000¹

1. List extra codes in sequence, separated by commas.
 2. Specify range in plain text.
 3. Specify range and output signal in plain text.
 4. For matching process connection adapters, see data sheet 40.9711

JUMO GmbH & Co. KG
Delivery address: Mackenrodtstraße 14,
36039 Fulda, Germany
Postal address: 36035 Fulda, Germany
Phone: +49 661 6003-0
Fax: +49 661 6003-607
e-mail: mail@jumo.net
Internet: www.jumo.net

JUMO Instrument Co. Ltd.
JUMO House
Temple Bank, Riverway
Harlow, Essex CM 20 2TT, UK
Phone: +44 1279 635533
Fax: +44 1279 635262
e-mail: sales@jumo.co.uk
Internet: www.jumo.co.uk

JUMO Process Control, Inc.
8 Technology Boulevard
Canastota, NY 13031, USA
Phone: 315-697-JUMO
1-800-554-JUMO
Fax: 315-697-5867
e-mail: info@jumo.us
Internet: www.jumo.us



Stock versions

(1)	-	(2)	-	(3)	-	(4)	-	(5)	-	(6)	-	(7)	/	(8)	Sales No.
902810/20	-	1001	-	2	-	6	-	100	-	681	-	24	/	000	90/00379859