

Beta RSC 55

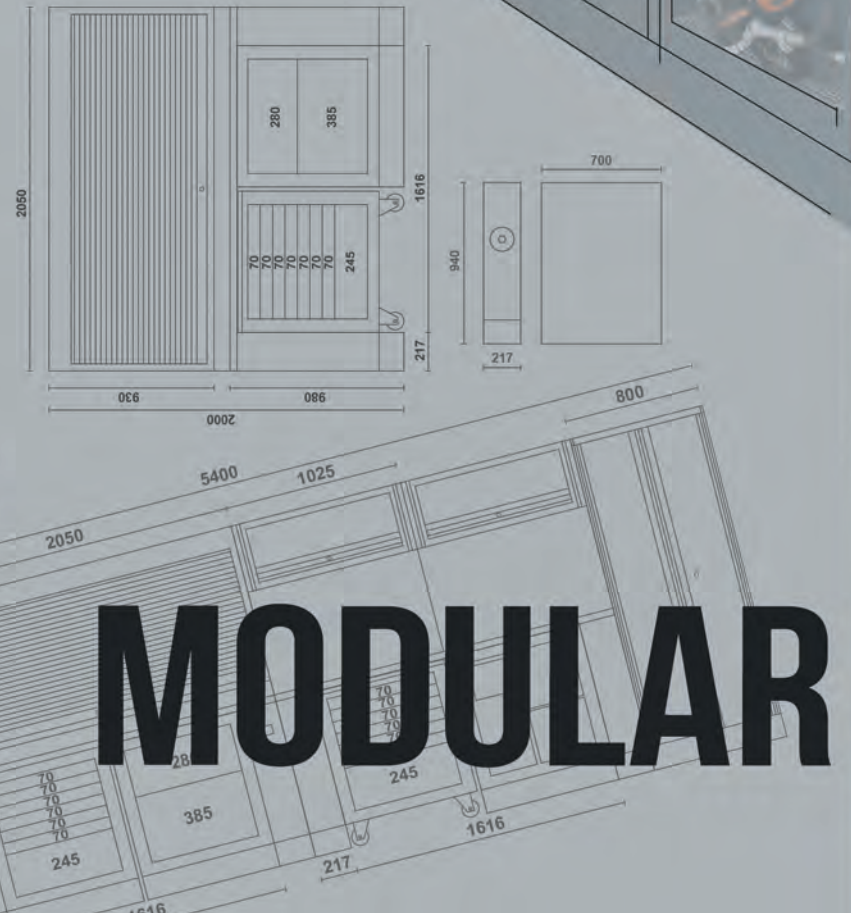
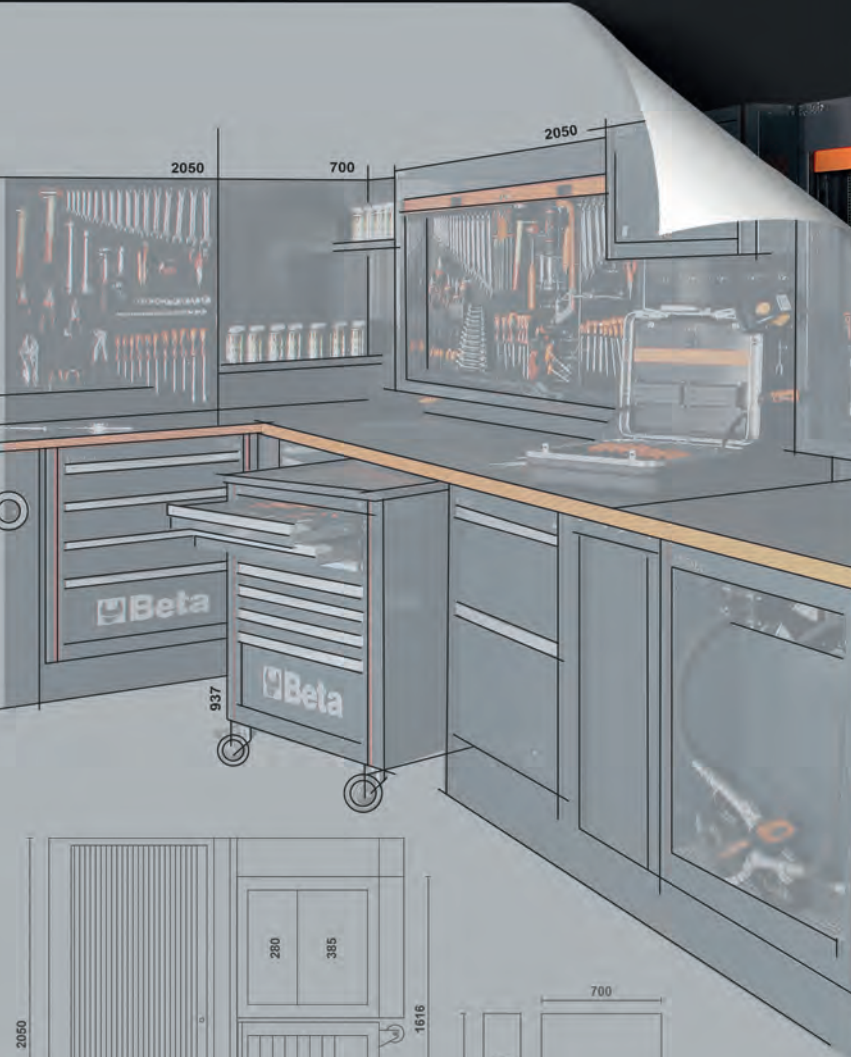

MODULAR

SYSTEM

www.beta-tools.com

5S

is a workplace organization method of Japanese origin. The name is derived from the western transcription of 5 Japanese words: **seiri, seiton, seiso, seiketsu and shitsuke.**



SEIRI SORT
Remove all unnecessary items from the workplace; only keep the items you need.

SEITON SET IN ORDER
Put everything into its proper place: a place for everything and everything in its place.

SEISO SHINE
Keep the workplace clean and tidy.

SEIKETSU STANDARDIZE
Establish consistent work practices to keep rationalizing resources and spaces, determining a standard to implement.

SHITSUKE SUSTAIN
Support and spread this mindset and behaviour across the organization.

BEFORE



Following the 5 steps identified by the words allows a systematic, repeatable method to be implemented with a view to optimized working standards and enhanced operating performance.

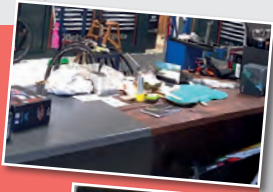

BENEFITS



Reduced time loss and improved cost-effectiveness

A proper organization and transport system for your tools will allow you to have everything you need, where you need it, and within reach.



Enhanced quality and productivity

Standard equipment does not always cater to our needs. Creating your equipment on an item-by-item basis will allow you to fully adapt it to your requirements, which will result in improved reliability and performance.



Fewer work accidents

Most accidents occur while using tools. Arranging all necessary items so that they can be easily selected for use and removing all unnecessary items will allow you to minimize misuse and reduce hazards.



Greater efficiency

Reducing the number of defects and errors will allow you to avoid delays, optimize processes and improve the company's results and efficiency.

AFTER



Beta

RSC 55

WORKSHOP EQUIPMENT C55

The modular workshop combination that allows you to create a modern work environment customized to fit your space and storage needs. Choose from a wide range of solutions sharing high quality standards, designed to make the most of your time by optimizing work.



DESIGN

Refined finish to make your workplace a neat, aesthetically captivating environment

SPACE ORGANIZATION

A rationally organized workbench system as synonymous with optimized work



QUALITY

Beta's best "Made in Italy" quality to furnish your workshop

MADE IN ITALY



MODULARITY

Modular workshop system, customized to fit your space and storage needs

C55

055000000

Comprehensive workshop equipment combination

Comprehensive combination comprising:

- Single-door tool cabinet (C55A1)
- Two-door tool cabinet (C55A2)
- Workbench (C55B0/2)
- Workbench with sockets (C55PRO B0/2)
- Mobile roller cab with 7 drawers (C55C7)
- Fixed module with 2 storage drawers (C55M2)
- Fixed module with 7 drawers (C55M7)
- Fixed service module (C55MS)
- Tool panel with suspended cabinets (C55/2PM)
- Tool panel with shutter (C55PS-0)



C55A1

C55PS-0



C55M7

C55M2

C55PRO B0/2



Cabinets fitted with 3 interior, vertically adjustable shelves



Compressed air outlet with built-in roller Ø 8 mm. Hose length: 10 m



Aluminium drawer front complete with quick release system throughout length of drawer



Aluminium shutter with lock for protecting tools

WORKSHOP EQUIPMENT COMBINATION

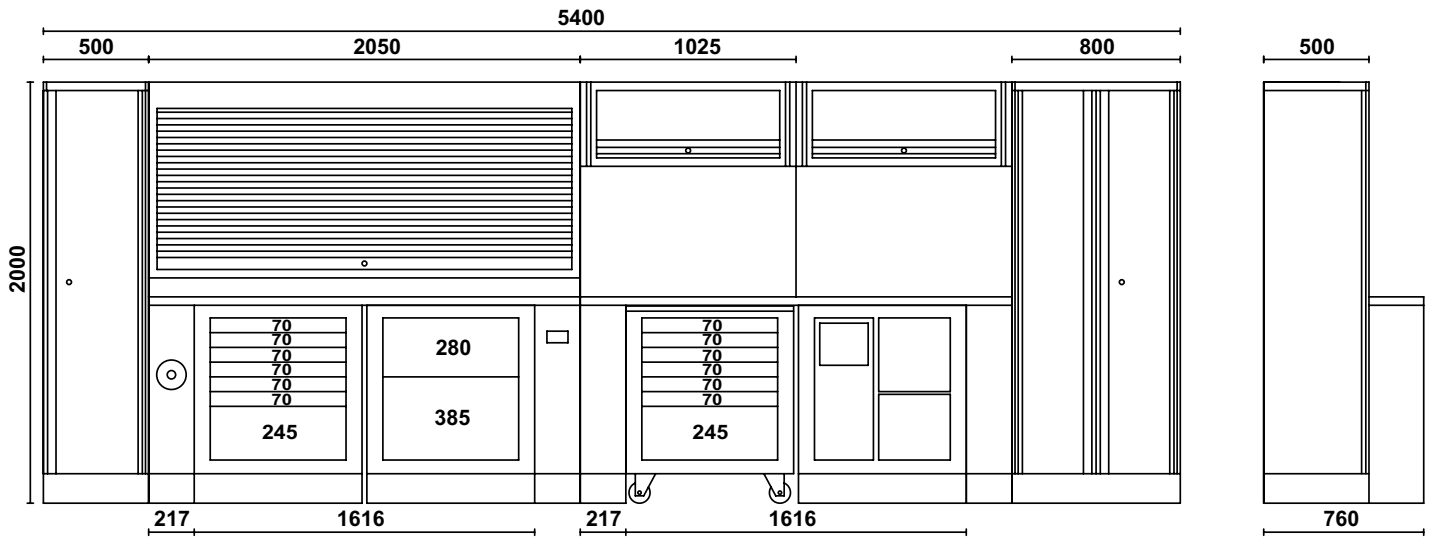

Suspended cabinets fitted with gas springs making it easier to open/close doors



Framework



Schuko socket
16+10A
and EU Plug 10A



Drawers can accommodate
thermoformed tool trays
available in price list



Mobile roller cab with 2 fixed
and 2 steering wheels,
making it easy to pull it out



Adjustable supporting feet
suitable for uneven surfaces

C55AB

055000020

Workshop equipment combination

Combination comprising:

- Two-door tool cabinet (C55A2)
- Workbench (C55B0/2)
- Fixed module with 7 drawers (C55M7)
- Fixed service module (C55MS)
- Tool panel with suspended cabinets (C55/2PM)

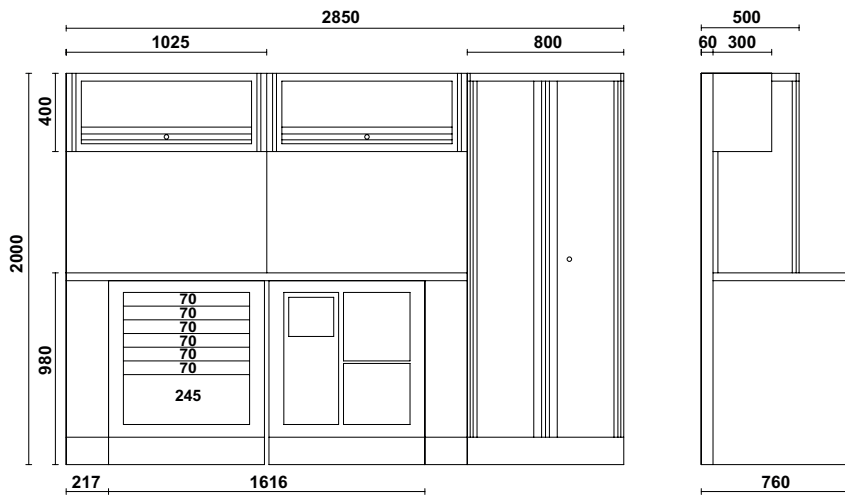
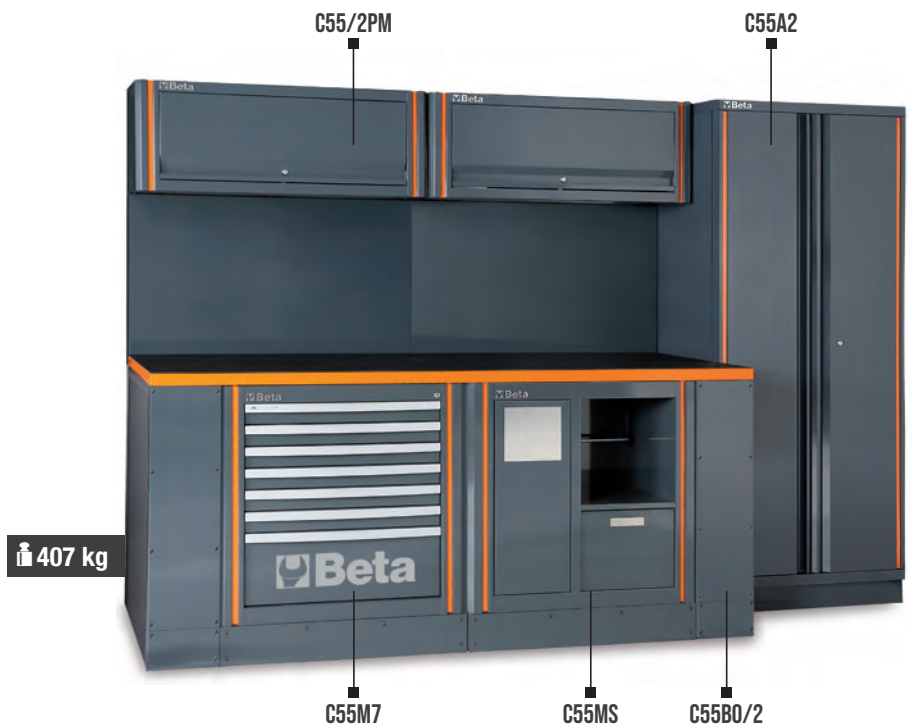

C55PB/3

055000035

Workshop equipment combination

Combination comprising:

- Workbench (C55B0/2)
- Mobile roller cab module with 8 drawers (C55C8)
- Fixed module with 2 storage drawers (C55M2)
- Wall tool system with shutter (C55PS-0)

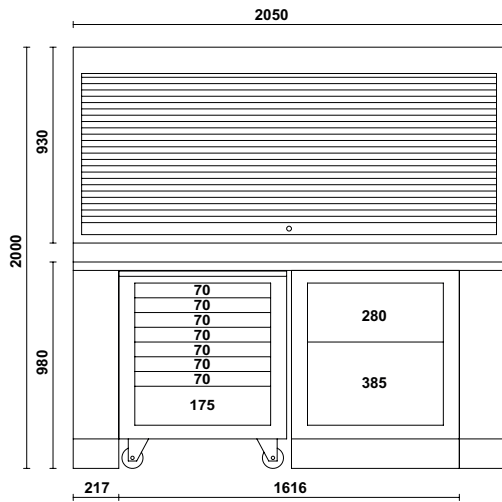

Choosing the workbench means the first step in any workshop furniture project. We at Beta offer pre-arranged solutions in versions **2, 2.8 and 4** metres in length (pages 11÷13), in grey and orange colours. However, you can configure the workbench according to your requirements, choosing the **worktop** (page 15) and the **legs** (page 14), which can be used for both sides, are fitted with vertically adjustable feet and are available in single and double versions, with power sockets and hose or cable reels.

The **modules** under the workbenches are the heart of the project: mobile or fixed, with drawers or service equipment (pages 16÷19).

The modular system also provides several different solutions for the **upper part**: plain, suspended or shuttered panels, which can accommodate power sockets (pages 20÷24).

Furthermore, a wide range of **accessories** allows you to complete the project, adapting it to your requirements (page 28).

The modular project can be extended and changed in time, as requirements and available spaces vary.

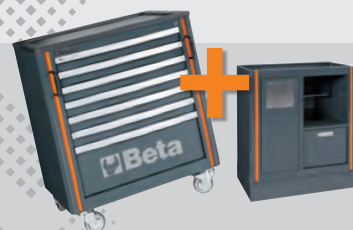

C55B/2



C55B0/2

055000101



C55B0/2

055000111

Two versions differ in worktop colour

2-m-long workbench

Worktop (2050x700 mm) covered with a shockproof, non-scratch PVC coat, resistant to hydrocarbons

- Holes for a vice (1599F/150, to be ordered separately)
- Can accommodate 2 modules under worktop
- Vertically adjustable feet

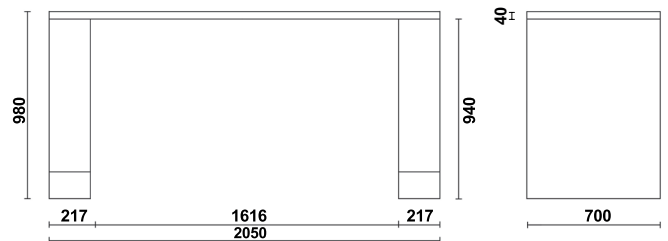

C55PRO B/2



C55PRO B0/2

055000151



C55PRO B0/2

055000171

Two versions differ in worktop colour

2-m-long workbench

Worktop (2050x700 mm) covered with a shockproof, non-scratch PVC coat, resistant to hydrocarbons

Built-in sockets and roller:

- Schuko socket+16+10A
- EU Plug 10A
- Compressed air outlet and roller, Ø 8 mm. Hose length: 10 m
- Holes for a vice (1599F/150, to be ordered separately)
- Can accommodate 2 modules under worktop
- Vertically adjustable feet

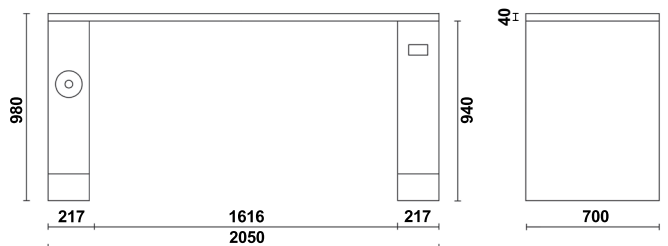

C55B/2,8



C55B0/2,8

055000261



C55BG/2,8

055000281

Two versions differ in worktop colour

2.8-m-long workbench

Worktop (2850x700 mm) covered with a shockproof, non-scratch PVC coat, resistant to hydrocarbons

- Holes for a vice (1599F/150, to be ordered separately)
- Can accommodate 3 modules under worktop
- Vertically adjustable feet

129 kg

600 kg

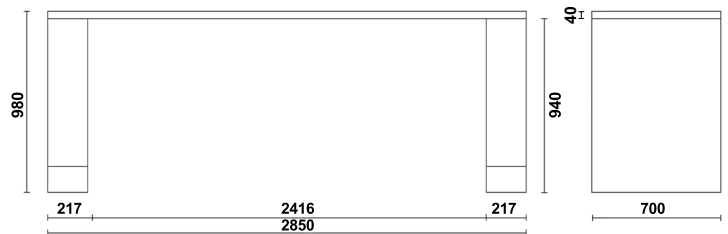

C55PRO B/2,8



C55PRO B0/2,8

055000271



C55PRO BG/2,8

055000283

Two versions differ in worktop colour

2.8-m-long workbench

Worktop (2850x700 mm) covered with a shockproof, non-scratch PVC coat, resistant to hydrocarbons

Built-in sockets and roller:

- Schuko socket+16+10A
- EU Plug 10A
- Compressed air outlet and roller Ø 8 mm. Hose length: 10 m
- Holes for a vice (1599F/150, to be ordered separately)
- Can accommodate 3 modules under worktop
- Vertically adjustable feet

134 kg

600 kg

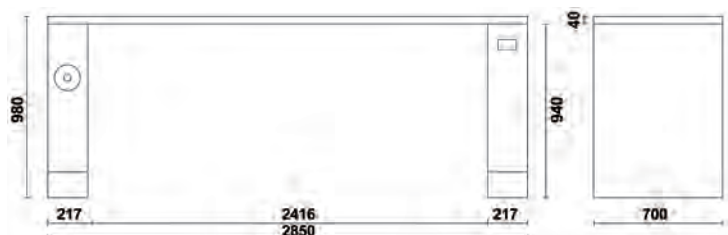

C55B/D4



C55B0/D4

055000109



C55BG/D4

055000119

Two versions differ in worktop colour

Double 4-m-long workbench with central leg

Worktop (4100x700 mm) covered with a shockproof, non-scratch PVC coat, resistant to hydrocarbons

- Holes for a vice 1599F/150 (to be ordered separately)
- Vertically adjustable feet
- Double central leg with compartment and slide-away door, 350x750 mm

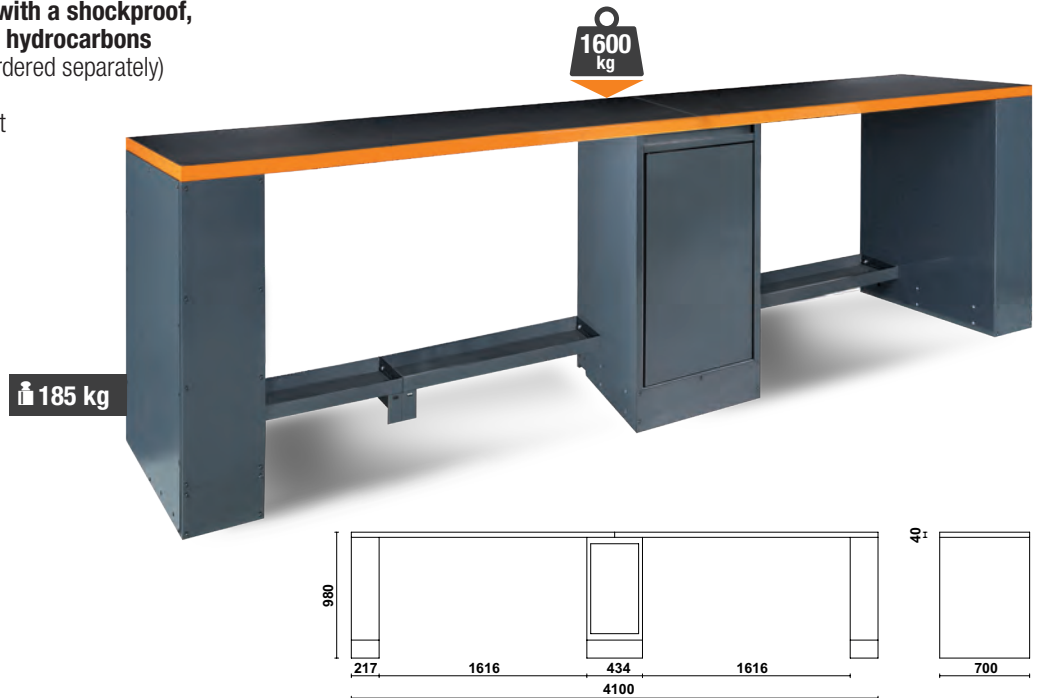

C55PRO B/D4



C55PRO B0/D4

055000159



C55PRO BG/D4

055000179

Two versions differ in worktop colour

Double 4-m-long workbench with central leg

Worktop (4100x700 mm) covered with a shockproof, non-scratch PVC coat, resistant to hydrocarbons

Built-in sockets and roller:

- Schuko socket+16+10A
- EU Plug 10A
- Compressed air outlet and roller Ø 8 mm. Hose length: 10 m
- Holes for a vice (1599F/150, to be ordered separately)
- Vertically adjustable feet
- Central double leg with slide-away door compartment, 365x750 mm

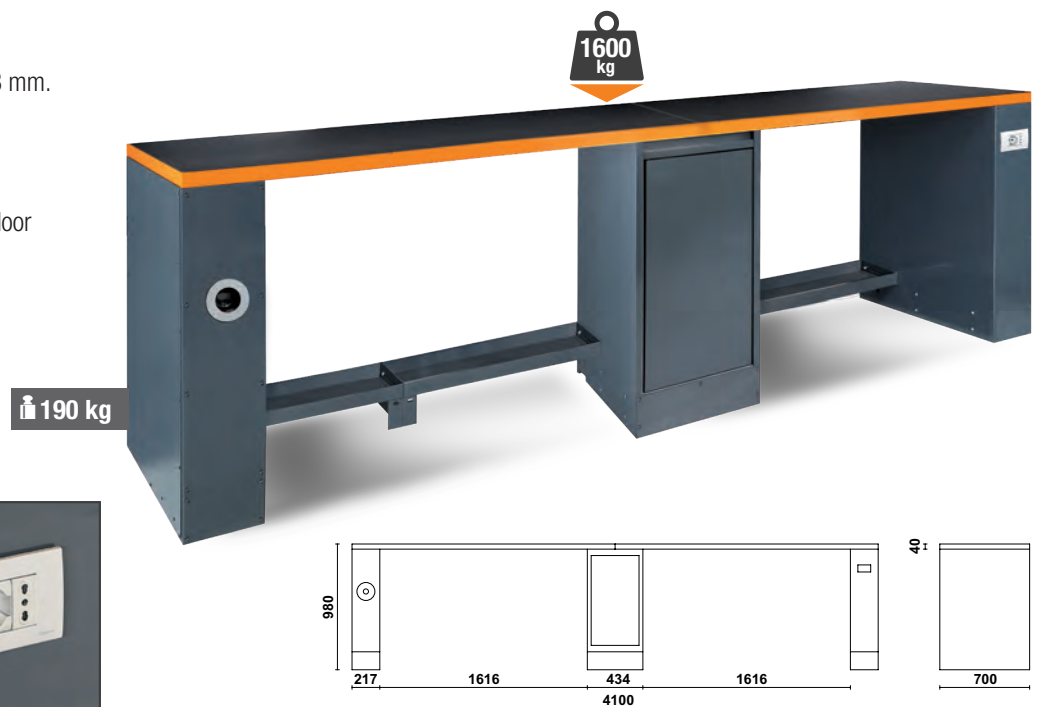

C55B/G

055000096

Universal leg for workbench

- With vertically adjustable feet
- Can be used for both workbench sides
- Front and side opening

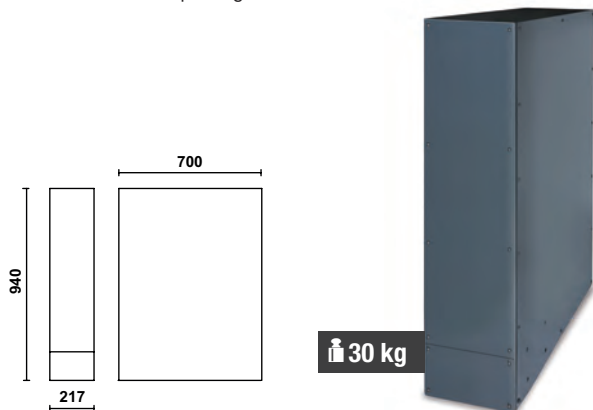

C55B/GAA

055000099

Universal leg for workbench with built-in hose reel

- Built-in automatic hose reel for compressed air or cold water (Ø 8 mm) item 1901BM/8
- Hose length: 10 m
- With vertically adjustable feet
- Front and side opening

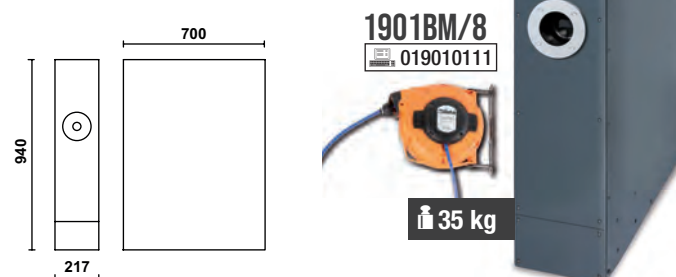

C55B/GDS

055000291

Double leg for adjoining workbenches

- Compartment with slide-away door, 365x750 mm
- With vertically adjustable feet

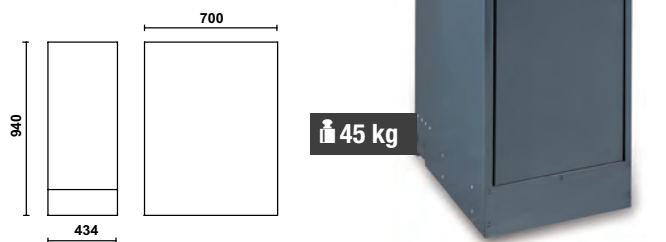

C55B/GDP

New Item

055000292

Double leg for adjoining workbenches

- Paper roll holder compartment
- Compartment with door
- With vertically adjustable feet



C55B/GE

055000097

Universal leg with power sockets for workbench

- Schuko socket+16+10A
- EU Plug 10A
- With vertically adjustable feet
- Front and side opening



C55B/GAE

055000094

Universal leg with built-in electrical cable reel for workbench

- Built-in automatic cable reel with Schuko type socket item 1848.
- Cable length: 15 m
- Thermally protected
- With vertically adjustable feet
- Front and side opening

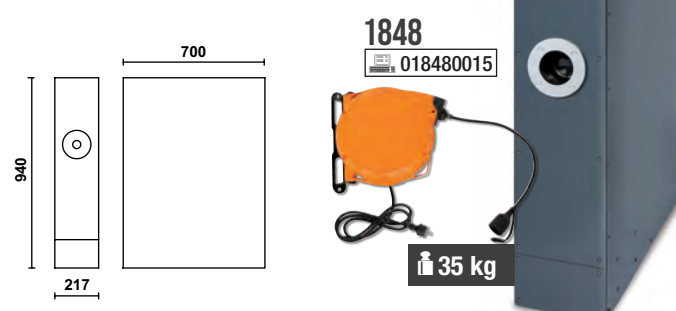

C55/PL-1,024



C55/PL0-1,024

055000130



C55/PLG-1,024

055000131

Two versions differ in worktop colour

1-m-long worktop for extension of workbench

Painted sheet metal worktop (1024x700 mm) covered with a shockproof, non-scratch PVC coat, resistant to hydrocarbons



pg 25

21 kg



C55B PT/2



C55B0 PT/2

055000106



C55BG PT/2

055000116

Two versions differ in worktop colour

2-m-long worktop, for workbench

Painted sheet metal worktop (2050x700 mm) covered with a shockproof, non-scratch PVC coat, resistant to hydrocarbons

Holes for a vice (1599F/150, to be ordered separately)



43 kg



C55B PT/2,8



C55B0 PT/2,8

055000266



C55BG PT/2,8

055000286

Two versions differ in worktop colour

2.8-m-long worktop, for workbench

Painted sheet metal worktop (2850x700 mm) covered with a shockproof, non-scratch PVC coat, resistant to hydrocarbons

Holes for a vice (1599F/150, to be ordered separately)



61 kg



C55RB

Scratch-proof PVC coat resistant to hydrocarbons

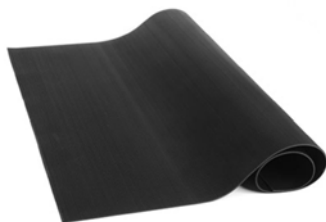

for 700x700mm long workbench

055000199

for 2-m-long workbench

055000195

for 1-m-long workbench

055000198

for 2.8-m-long workbench

055000196

C55B/VS

055000095

Lower workbench bracket for workshop workbenches

Dimensions: 800x230x60 mm



4 kg

1599F/150

015990150

Parallel bench vice with hardened top and slides

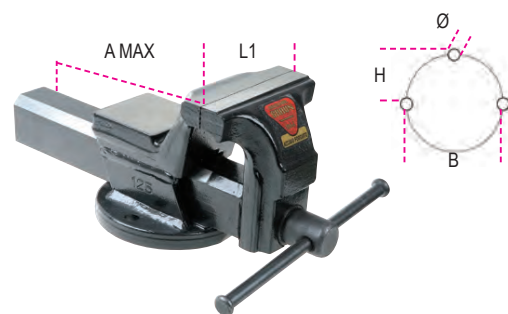

L1	BxH	Ø	A Max
150 mm	125x62 mm	13 mm	200 mm

C55T3

055000219

Trolley

- 3 tops covered in antislip ribbed rubber
- Ergonomic handle
- Two fixing options for central worktop
- Four castors Ø 100 mm: 2 fixed and 2 steering with brake
- Static load capacity: 200 kg (distributed between 3 shelves)

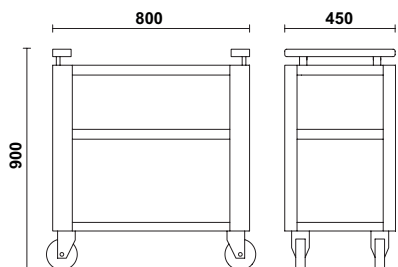

21 kg

200 kg



C55C7

055000201

Mobile roller cab with 7 drawers

7 drawers (588x367 mm), with ball bearing slides

- 4 castors Ø 100 mm, 2 fixed (one with brake) and 2 steering
- Aluminium opening system throughout length of drawer
- Drawer bases protected by foamed rubber mats
- Front centralized lock
- Can be fitted with foam trays

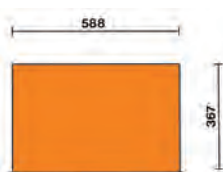
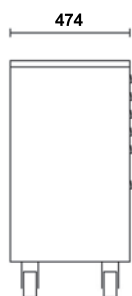
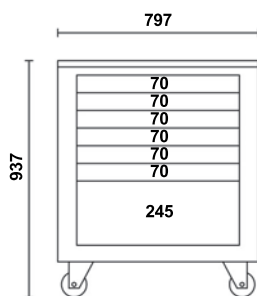

h	max
70 mm	30 kg
245 mm	40 kg

79 kg

1000 kg



C55C8

055000206

Mobile roller cab with 8 drawers

8 drawers (588x367 mm) with ball bearing slides

- 4 castors Ø 100 mm, 2 fixed (one with brake) and 2 steering
- Aluminium opening system throughout length of drawer
- Drawer bases protected by foamed rubber mats
- Front centralized lock
- Can be fitted with foam trays

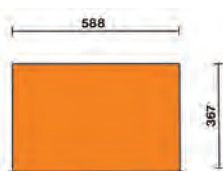
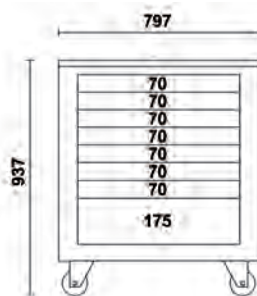

h	max
70 mm	30 kg
175 mm	40 kg

81 kg

1000 kg



C55M4 Fixed module with 4 drawers

055000212

4 drawers (588x367 mm) with ball bearing slides

- Aluminium opening system throughout length of drawer
- Drawer bases protected by foamed rubber mats
- Front centralized lock

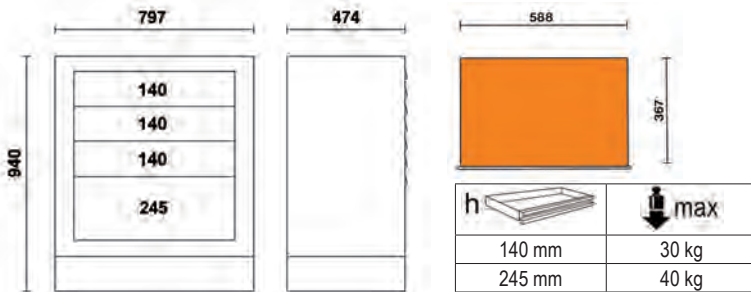

75 kg



C55M7 Fixed module with 7 drawers

055000203

7 drawers (588x367 mm) with ball bearing slides

- Aluminium opening system throughout length of drawer
- Drawer bases protected by foamed rubber mats
- Front centralized lock
- Can be fitted with foam trays

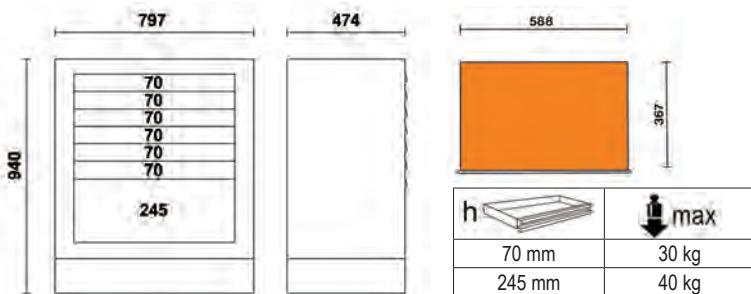

78 kg



C55M8 Fixed module with 8 drawers

055000207

8 drawers (588x367 mm) with ball bearing slides

- Aluminium opening system throughout length of drawer
- Drawer bases protected by foamed rubber mats
- Front centralized lock
- Can be fitted with foam trays

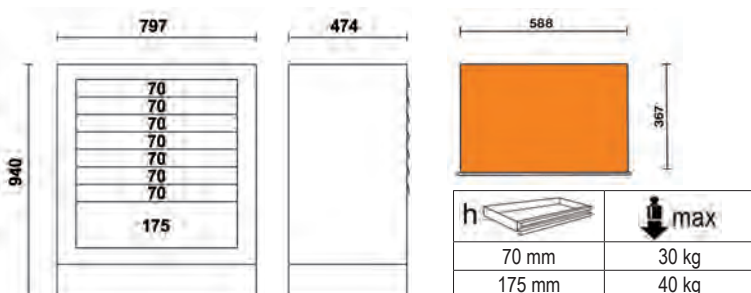

78,9 kg



C55M2

Fixed module with 2 drawers

2 drawers (588x367mm) with ball bearing slides

- Aluminium opening system throughout length of drawer
- Drawer bases protected by foamed rubber mats
- Front centralized lock

055000202

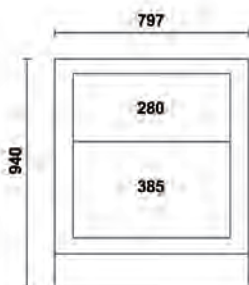

h	max
280 mm	40 kg
385 mm	40 kg

66 kg



C55MS

Fixed service module

- Built-in waste bin
- Perforated paper roll compartment
- Storage drawer, 305x270 mm

055000204

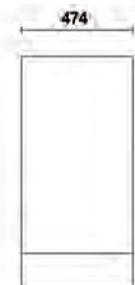

75 kg



C55CS

Fixed module for separate waste

- Pull-out waste compartment (588x465 mm) with ball bearing slides
- 2 capacious pull-out interior containers for sorting waste

055000208

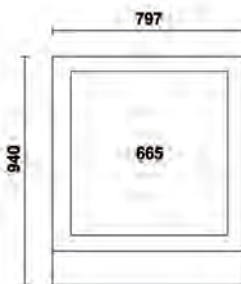

62 kg



C55MA

Fixed two-door module

055000205

- Push Pull opening
- With lock
- Interior shelf, vertically adjustable

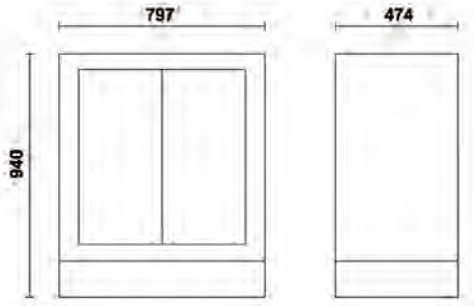

75 kg



C55MDO

Fixed oil distribution module

055000210

- 2 reels with 7m - 1/2" hose included
- Complete with 2 oil guns with digital litre counter with automatic drip catcher.
 - max. delivery rate: 0÷35 l/min
 - viscosity: 8÷5000 mPas

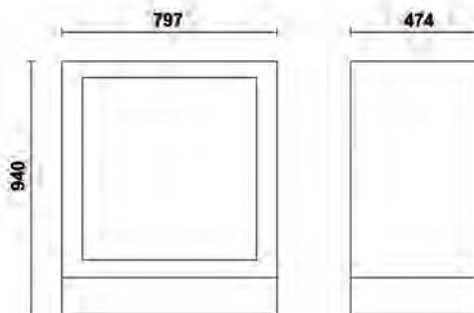

94 kg



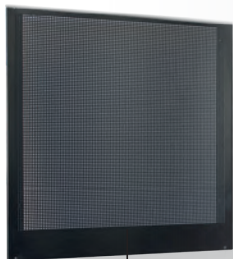

C55PFA-1,0

C55PFA-1,0

055000316

Self-supporting perforated panel, 1-m-long

Perforated steel tool panel (1024x25x1000 mm)



C55PM

C55PT1,0X0,6

C55PM

055000302

Suspended cabinet, 1-m-long

Dimensions: 1024x400x300 mm; fitted with gas springs, making it easier to open and close door

C55PT1,0X0,6

055000314

Under-cabinet panel, 1-m-long

Dimensions: 1024x25x620 mm



C55PM

C55PTE-1,0

C55PM

055000302

Suspended cabinet, 1-m-long

Dimensions: 1024x400x300 mm; fitted with gas springs, making it easier to open and close door

C55PTE-1,0

055000319

Under-cabinet panel, 1-m-long

Dimensions: 1024x25x620 mm

Accommodates 2 power sockets (not included)



C55PM

C55PT1,0X0,6

C55/PF

C55PM

055000302

Suspended cabinet, 1-m-long

Dimensions: 1024x400x300 mm; fitted with gas springs, making it easier to open and close door

C55PT1,0X0,6

055000314

Under-cabinet panel, 1-m-long

Dimensions: 1024x25x620 mm

C55/PF

055000307

Perforated under-cabinet panel, 1-m-long

Perforated tool panel (1024x620 mm) designed to match **C55PT1,0X0,6**

C55P/MCD

055000257

Double central intermediate uprights

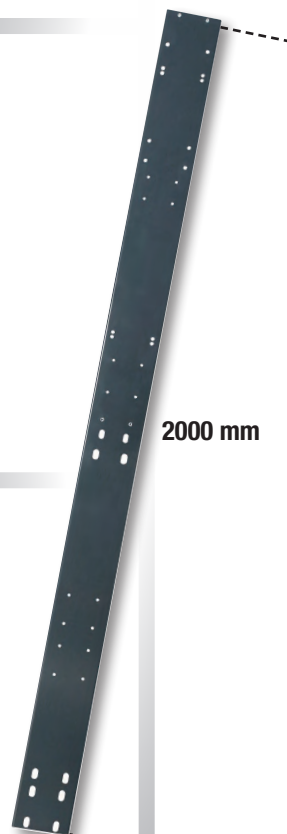

2000 mm

C55/2PM

055000301

Tool wall system with 2 suspended cabinets

- 2 suspended cabinets, 1024x400x300 mm, fitted with gas springs, making it easier to open and close doors
- 2 wall panels, 1024x620 mm; can accommodate perforated tool panels C55/PF (to be ordered separately)
- Supplied with framework
- Matches 2-m-long workbench



C55PFA-1,0

055000316

Self-supporting perforated panel, 1-m-long

Perforated steel tool panel (1024x25x1000 mm)

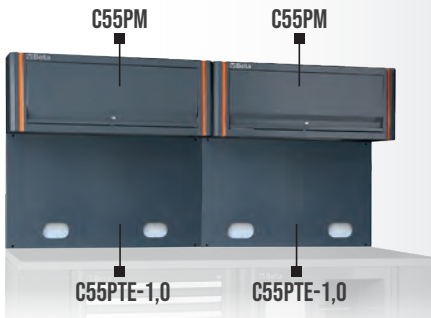

C55PM

055000302

Suspended cabinet, 1-m-long

Dimensions: 1024x400x300 mm; fitted with gas springs, making it easier to open and close door

C55PTE-1,0

055000319

Under-cabinet panel, 1-m-long

Dimensions: 1024x25x620 mm

Accommodates 2 power sockets (not included)



C55PM

055000302

Suspended cabinet, 1-m-long

Dimensions: 1024x400x300 mm; fitted with gas springs, making it easier to open and close door

C55PT1,0X0,6

055000314

Under-cabinet panel, 1-m-long

Dimensions: 1024x25x620 mm

C55/PF

055000307

Perforated under-cabinet panel, 1-m-long

Perforated tool panel (1024x620 mm) designed to match C55PT1,0X0,6



C55P/2MDX-SX

055000253

Right/left wall uprights, pair



C55P/MCD

055000257

Double central intermediate uprights



C55PS



Light grey shutter



Tool wall system with shutter

- Aluminium shutter, vertically adjustable, with lock
- Removable perforated tool panel
- Supplied with framework
- 50-hook GPS kit included
- Matches 2-m-long workbench

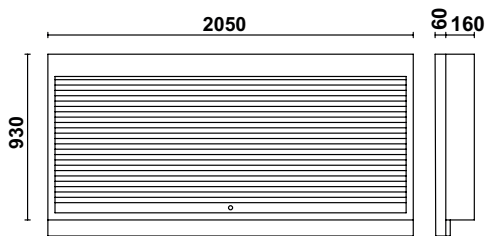

88 kg



C55PSE



Light grey shutter



Tool wall system with shutter accommodating 2 power sockets

- Aluminium shutter, vertically adjustable, with lock
- Removable perforated tool panel
- Supplied with framework
- 50-hook GPS kit included
- Accommodates power sockets (not included)
- Matches 2-m-long workbench

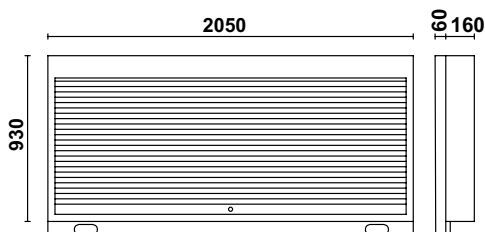

88 kg



5958U

059581008

**Assortment of 85 tools
for universal use
hooks included**



Quantity/Description	Beta N.
17 combination wrenches 6+22 mm	42NEW
12 offset hexagon key wrenches \odot 2+10 mm	96N/SC12
13 1/2" square drive hexagon sockets with rail \odot 10+22 mm	920A/SB13
8 1/2" square drive hexagon sockets with rail \odot 23+32 mm	920A/SB8
1 1/2" drive extension bar 125 mm	920/21
1 1/2" drive extension bar 255 mm	920/22
1 1/2" drive universal joint	920/25
1 1/2" drive sliding T-handle	920/42
1 1/2" drive reversible ratchet \oplus	920/55
1 circlip pliers straight, internal \odot 180 mm	1032
1 circlip pliers straight, external \bullet 175 mm	1036
1 slip joint pliers boxed joints 250 mm	1048
1 self - locking pliers 240 mm	1052
1 heavy-duty diagonal cutting nippers ∇ 160 mm	1084BM
1 electrician's scissors, straight blades	1128BMX
1 half-round needle nose pliers \equiv 180 mm	1150BM
1 extra-long needle nose pliers \bullet 160 mm	1166BM
7 screwdrivers for cross head Phillips® screws \bullet 3x75 - 3,5x100 - 4x125 - 5,5x150 - 6,5x150 - 8x200 - 10x200 mm	1260
4 screwdrivers for cross head Phillips® screws \oplus PH0x60 - PH1x80 - PH2x100 - PH3x150 mm	1262/S4
1 engineer's hammer 300 g	1370
1 soft face hammer \varnothing 35 mm	1390
1 measuring tape 5 m	1692
5 set of 5 second-cut files, with handles 200 mm	1719BMA/S5
1 hacksaw frame, aluminium handle	1725
1 plastic oil can 150 cc	1754
1 snap - off blade utility knife	1771



Quantity/Description	Beta N.
6 pin punches 2 + 8 mm	31/SP6
6 2 drift punches, 1 centre punch, 3 flat chisels with metal holder	38/SP6
17 combination wrenches 6+22 - 24 - 27 - 30 - 32 mm	42NEW/S17X
12 double open end wrenches 6x7 + 30x32 mm	55/S12X
8 offset hexagon key wrenches 2 + 10 mm	96T/S8
8 offset key wrenches, for Torx® head screws \odot T9 + T40	97TX/SC8
1 adjustable wrench 250 mm	111
13 1/2" square drive hexagon sockets with rail \odot 10 + 22 mm	920A/SB13
8 1/2" square drive hexagon sockets with rail \odot 23 + 32 mm	920A/SB8
7 socket drivers for cross head Phillips® screws \bullet \oplus 1,2x65 - 1,2x8 - 1,6x9 - 2x12mm - PH1-PH2-PH3	920LH/SB7
1 circlip pliers straight, internal \odot 180 mm	1032
1 circlip pliers bent, internal \odot 170 mm	1034
1 circlip pliers straight, external \bullet 175 mm	1036
1 circlip pliers bent, external \bullet 175 mm	1038
1 slip joint pliers boxed joints 250 mm	1048
1 self - locking pliers 240 mm	1052
1 tin snips 250 mm	1112
1 electrician's scissors, straight blades	1128BMX
8 set of screwdrivers 2,5x50 - 3x75 - 4x100 - 5,5x125 - 6,5x150 - PH0 - PH1 - PH2	1263/D8
2 engineer's hammer 300 - 600 g	1370
1 soft face hammer 35	1390
1 measuring tape 5 m	1692/5
1 flexible magnetic pick-up tool	1712E/2
1 two cutting edges scraper 200 mm	1717A
1 three - cutting edges scraper 200 mm	1717B
5 second cut files 200 mm	1719BMA8/S5
1 metal oil can 200 cc	1751
1 snap - off blade utility knife	1771BM
1 1/2" drive extension bar 125 mm	920/21
1 1/2" drive extension bar 250 mm	920/22
1 1/2" drive universal joint	920/25
1 1/2" drive sliding T-handle	920/42
1 1/2" drive reversible ratchet \oplus	920/55
1 pry bar	963
1 Diagonal cutting nippers ∇ 160 mm	1082BM
1 Heavy-duty diagonal cutting nippers ∇ 160 mm	1084BM
1 toggle lever assisted end cutting nippers ∇ 180 mm	1092V
1 half-round needle nose pliers \equiv 180 mm	1150BM
1 Extra-long needle nose pliers \bullet 160 mm	1166BM
1 Extra-long bent needle nose pliers \bullet 160 mm	1168BM
2 screwdrivers for cross head Phillips® screws \bullet 8x200 - 10x200 mm	1260
1 screwdrivers for cross head Phillips® screws \oplus PH3 8x150mm	1262
1 sliding gauge	1650
1 hacksaw frame, aluminium handle 420 mm	1725

5957U-P

059571004

**Assortment of 133 tools
for universal use
hooks included**



Solutions

2m + 0,80



C55PFA-0,8

055000315

Self-supporting perforated panel, 0.8-m-long

Perforated steel tool panel (800x25x1000 mm)



C55P/MCD

055000257

Double central intermediate uprights



C55PM/MO,8

055000312

Suspended cabinet, 0.8-m-long

Dimensions: 800x400 mm; fitted with gas springs making it easier to open and close door



C55PTE-0,8

055000318

Under-cabinet panel, 0.8-m-long

Dimensions: 800x400 mm

Accommodates 1 power socket (not included)



2000 mm



C55PM/MO,8

055000312

Suspended cabinet, 0.8-m-long

Dimensions: 800x400 mm; fitted with gas springs making it easier to open and close door



C55PT0,8X0,6

055000313

Under-cabinet panel, 0.8-m-long

Dimensions: 800x25x620 mm

C55/1PF

055000309

Perforated under-cabinet panel, 0.8-m-long

Perforated tool panel (800x620 mm)

C55AC



C55AC O

055000360



C55AC G

055000380

Two versions differ in worktop colour

Self-supporting complete corner

- Worktop (700x700 mm) with legs
- 2 upper tool wall systems complete with 2 fixing shelves (670x160 mm)



C55KAI



C55KAI O

055000365



C55KAI G

055000385

Two versions differ in worktop colour

Corner worktop, 700x700 mm combination with legs

Painted sheet metal worktop (700x700 mm) covered with a shockproof, non-scratch PVC coat, resistant to hydrocarbons



C55B/1



C55B0/1

055000090



C55BG/1

055000091

Two versions differ in worktop colour

Extension workbench, 1-m-long

Worktop (1024x700 mm) covered with a shockproof, non-scratch PVC coat, resistant to hydrocarbons

- Universal leg with vertically adjustable feet
- 1 fixed module: 7 drawers (588x367 mm) with ball bearing slides



To be used
in combination
with C55KAI

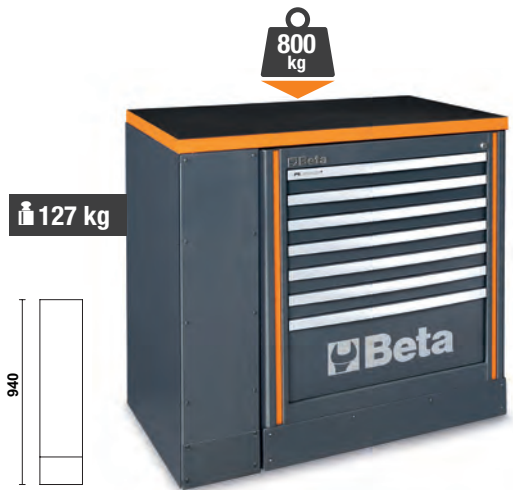
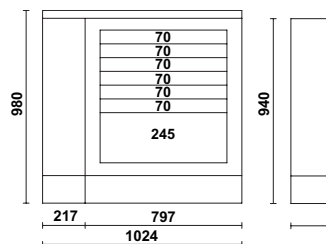

C55KAS

055000370

Upper corner with tool wall systems

- 2 perforated tool wall systems (700x1000 mm)
- 2 fixing shelves (670x160 mm)



C55MP

055000374

Steel shelves for corner elements

4 kg



C55AT1

New Item

055000421

Sheet metal tool cabinet with clear polycarbonate door

- 3 removable, vertically adjustable shelves
- With lock
- Usable interior dimensions: 1770x420x420 mm

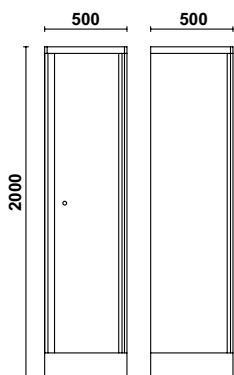

41 kg



C55AT2

New Item

055000422

Sheet metal tool cabinet with clear polycarbonate door

- 3 removable, vertically adjustable shelves
- With lock
- Usable interior dimensions: 1770x700x420 mm

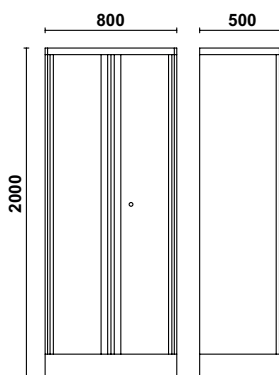

56 kg



C55A1

055000411

Sheet metal single-door tool cabinet

- 3 removable, vertically adjustable shelves
- With lock
- Usable interior dimensions: 1770x420x420 mm

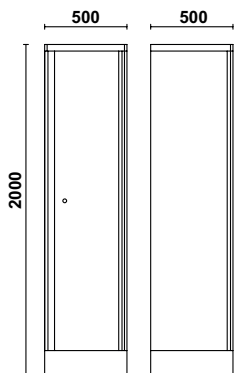

50 kg



C55A2

055000412

Sheet metal two-door tool cabinet

- 3 removable, vertically adjustable shelves
- With lock
- Usable interior dimensions: 1770x700x420 mm

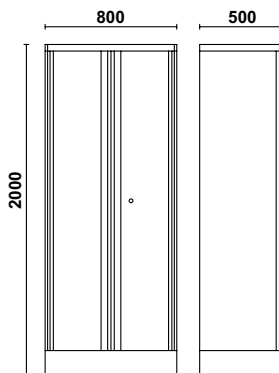

72 kg



C55A1/R42

055000461

Interior shelf for tool cabinet C55A1

400x400 mm



C55A2/R70

055000462

Interior shelf for tool cabinet C55A2

700x400 mm



C55C

055000400

Cargo cabinets

Developed on the basis of accurate research conducted with trained, professional users, they provide ideal solutions for working comfortably and rationally.

The opening system of the perforated panels of the two doors also allows the interior surface to be made the most of.

Caratteristiche principali:

- 1 drawer with ball bearing slides.
- Easy tool layout according to users' needs.
- Easy wall mounting by means of two slots located at the back of the cabinet.
- Safety lock for both drawers and doors.
- Empty thermoformed tray for 1/2" sockets and accessories.



37 kg

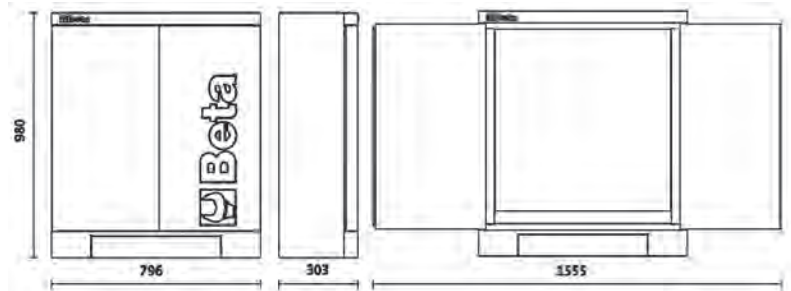

C45LMP

045000320

LED lamp for workshop equipment combination C45 - RSC55

- Length: 630 mm
- Easy to fix under wall cabinet through adhesives
- ON/OFF switch
- 570 lumens

Input: 100-240V 0,6A
Output: 12V 1.50A 18.0W



CP

088880470

Wall-mounted bottle holder rack, made of steel

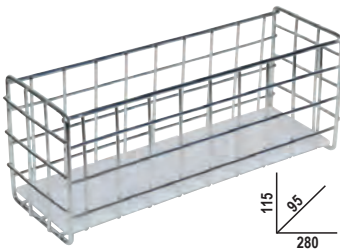

PM/6C

088880440

6-tray tool holder, made of plastic, with support

- Interior dimensions of tray: 80x60 mm



PM/5C

088880450

5-tray tool holder, made of plastic, with support

- Interior dimensions of tray: 95x120 mm



KIT/GPS

088880119

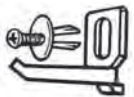

GM

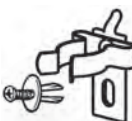

	Ø
088880250	6,5
088880251	9,5
088880252	13
088880253	16
088880254	19
088880255	25

S55/8

088880420

55/S8
55AS/8
55MP/S8

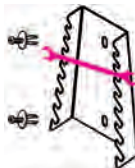

S55/12

088880421

55/S12
55/S12X
55AS/12
55MP/S12

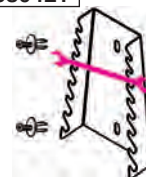

ST2P

088880422

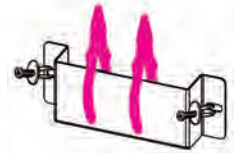

TSP

088880402

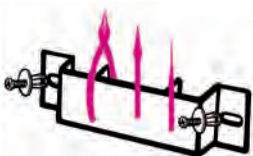

S952/10

088880423

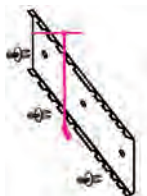

S1719BM

088880404

1719BMA: Q-T-P-M-R
1719BMD: Q-T-P-M-R

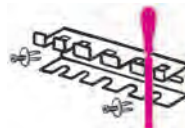

SGN

088880405

1290N-1292N-1299N/PZ
1260N-1262N-1269N/PZ
1201N-1202N-1209N/PZ

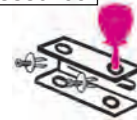

S42/17

088880428

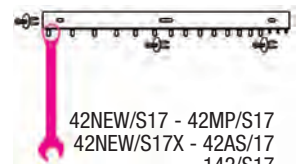

S951/6

088880429

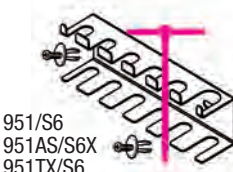

SPG11

088880910

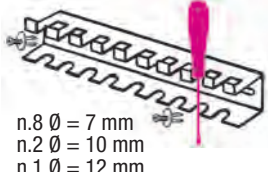

S1203/8

088880430

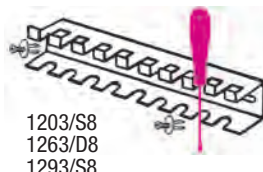

S96T/8

088880431

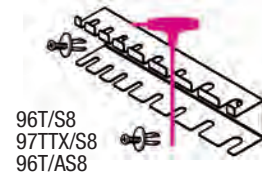

96T/SPV

000960958

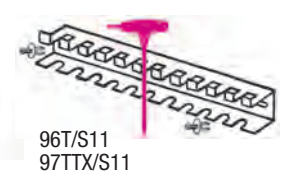

RSC55 allows you to order the benches and tool wall system with shutter in a neutral (grey) version and customize the vertical coloured inserts by choosing from 7 different adhesive tapes.



1. Order your modules in a neutral colour

2. Order the vertical insert

Now choose the colour to your taste or according to your company's colours.



C55STR Adhesive tape 25 m

allows to tailor the vertical tapes of garage furniture item C55



2011		055000901
9006		055000902
3000		055000903
5015		055000904
1023		055000905
6029		055000906
9016		055000907
1035		055000909



IMAGINE AND CREATE...

Configure your workshop
in 3D online

www.rsc55.com

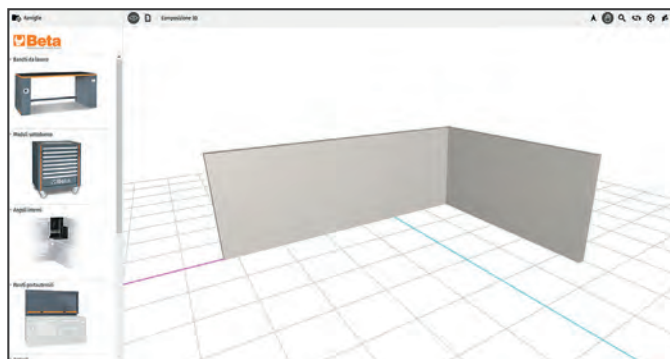

STEP 1

Draw the walls

Create the walls according to the dimensions of your workshop.

STEP 2

Design your workbench system

Select and assemble the component parts, to make your own combination.



STEP 3

View the result in 3D

The combination is immediately displayed in 3D and can be viewed from different angles.

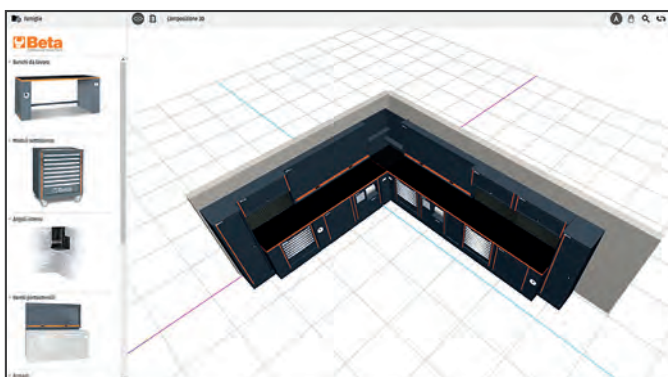

STEP 4

Request a quote

Print the detail of the arrangement in PDF format and take it to your dealer to get a quote.

ORDINE		CLIENTE	
Ordine numero:		Ateneo	
Data:	02 / 12 / 2020	Sezione e linea:	
Sede empresa:	92 / 80 / 8888	Indirizzo:	
Operatore:		Telefono:	
Costi Minimo:	€5	Mail:	
Banchi da lavoro			
	Articolo: 05000004 Codice: C58/1AE Descrizione: Gamba universale con avvitatore elettrico integrato per banco da lavoro armato officina	Quantità: 3	Importo: 0
	Articolo: 05000009 Codice: C58/1AA Descrizione: Gamba universale per banco da lavoro con avvitatore integrato	Quantità: 3	Importo: 0
	Articolo: 05000708 Codice: C58-PT2 Descrizione: piano di lavoro da 2 metri per banco armato officina	Quantità: 1	Importo: 0
	Articolo: 05000268	Quantità: 2	

CUSTOMIZED MODULES ON REQUEST

Fill your drawers with customized modules in six steps

(Max size: 1100 x 600 mm)

1 Determine your needs and send your project to the Beta dealer

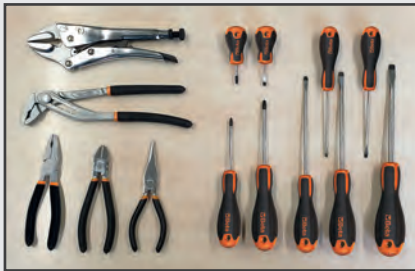

2 We will receive and codify your initial assortment of the project

Image	Product	Code Beta
	Self-locking pliers	010540022
	Pliers	010440250
	Pliers	011500046
	Screwdrivers for slotted head screws	012011039
	Screwdrivers for cross head Phillips® screws	012021018

3 We will execute the design



4 We will submit the final layout for your approval

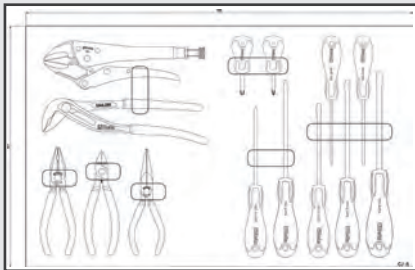

5 We will build the soft modules in Beta's factory in Sovico



6 We will deliver the tools in the customized modules



Contact our dealers
www.beta-tools.com/en/find-a-dealer/

998011093

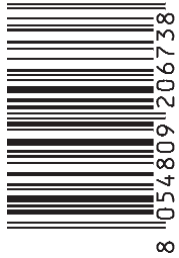

Beta

www.beta-tools.com

Beta Utensili S.p.A.
via Volta, 18
20845 Sovico (MB)
tel +39 039 20771
www.beta-tools.com

